

---

**SCINTREX**

**CG—3/3M AUTOGRAV  
AUTOMATED GRAVITY METER**

**OPERATOR MANUAL**



# SCINTREX LIMITED

## **Head Office**

222 Snidercroft Road  
Concord, Ontario  
Canada, L4K 1B5

Tel.: (905) 669-2280  
Fax: (905) 669-6403  
Telex: 06-964570

## **In the U.S.**

525 Fort Worth Drive  
Suite 214  
Denton, Texas 76201

Tel.: (817) 591-7755  
Fax: (817) 591-1968

## **In Australia**

1031 Wellington St.  
West Perth,  
West Australia 6005

Tel: (619) 321-6934  
Fax: (619) 481-1201

**P.N: 858 700**  
**Version 5.00**

**August 1995**

**Section 1: INSTRUMENT OVERVIEW**

**Section 2: GETTING STARTED**

**Unpacking the Instrument** . . . . . 2-1

    Unpacking . . . . . 2-2

    Removing the Dust Cover . . . . . 2-2

**Starting up the Autograv** . . . . . 2-3

**Powering up the Autograv** . . . . . 2-4

**Using the Keypad** . . . . . 2-6

    The Keypad . . . . . 2-6

        Top Functions (Operations Mode) . . . . . 2-7

        Bottom Functions (Enter Mode) . . . . . 2-9

**The Display** . . . . . 2-10

    Parameter Setup Display . . . . . 2-10

    Menu Structure . . . . . 2-10

        Moving Between Menus . . . . . 2-10

        Selecting a Menu . . . . . 2-11

        Modifying Parameters . . . . . 2-12

**Initializing the Instrument Parameters** . . . . . 2-15

**The Display during Readings** . . . . . 2-25

**Setting up the Tripod** . . . . . 2-26

    Tripod Extender Legs . . . . . 2-29

**Temperature Compensation** . . . . . 2-31

    Checking . . . . . 2-31

    Adjusting Temp. Compensation Offset . . . . . 2-32

**Adjusting Drift Corrections** . . . . . 2-36

**Setting up for Field Measurements** . . . . . 2-41

**Recalling Data** . . . . . 2-42

    Scrolling in Memory . . . . . 2-42

    Scanning the Records . . . . . 2-43

    Directly Accessing a Record from Memory . . . . . 2-45

    Recalling Data in the Cycling Mode . . . . . 2-46

    Exiting from the Memory Mode . . . . . 2-46

---

## Section 3: INSTRUMENT PARAMETERS

<b>Main Menu (Auxiliary Mode)</b> . . . . .	3-1
<b>Auxiliary Mode</b> . . . . .	3-2
<b>INITIALISE Menu</b> . . . . .	3-3
INITIALISE Submenus . . . . .	3-3
<b>LINE SEP</b> . . . . .	3-14
<b>STN SEP</b> . . . . .	3-15
<b>AUTOGRAV SETUP</b> . . . . .	3-16
AUTOGRAV SETUP Submenus . . . . .	3-16
<b>OUTPUT</b> . . . . .	3-30
OUTPUT Submenus . . . . .	3-31
<b>EDIT</b> . . . . .	3-39
<b>LOCK AUX.</b> . . . . .	3-40
Locking the Auxiliary mode . . . . .	3-40
Unlocking Auxiliary mode . . . . .	3-40

## Section 4: FIELD OPERATION

<b>Parameter Setup and Keypad Operation</b> . . . . .	4-1
Reading Time — Terminating a Reading . . . . .	4-2
Cal. After . . . . .	4-2
Levelling Requirements and Continuous Tilt Correction . . . . .	4-3
<b>Recording Data</b> . . . . .	4-4
Auto Rejection . . . . .	4-4
Notebook Feature . . . . .	4-5
<b>Transporting and Handling</b> . . . . .	4-6
<b>Operation Hints</b> . . . . .	4-6
Transportation . . . . .	4-7
Motion Noise . . . . .	4-8
Wind . . . . .	4-9
Base Station Selection . . . . .	4-9
Cold Weather Operation . . . . .	4-10
<b>Using the CG-3 before Warm-up Stabilization is Complete</b> . . . . .	4-10
<b>Dumping Data</b> . . . . .	4-11

---

## Section 5: BATTERY AND CHARGER

<b>Loss of Power</b> .....	5-1
<b>Battery</b> .....	5-2
Temperature Effects .....	5-2
Voltage .....	5-3
Life Expectancy .....	5-4
Replacing .....	5-5
<b>Charger</b> .....	5-5
Charging Time .....	5-6
Charger Line Voltage .....	5-6
Selecting an alternate voltage .....	5-6
<b>Battery Compartment Fuse</b> .....	5-8
<b>How to Change a Battery</b> .....	5-8

## Section 6: MAINTENANCE

<b>Temperature Compensation</b> .....	6-1
<b>Drift Correction</b> .....	6-2
Obtaining Accurate Drift Correction Results .....	6-2
Using a Chart Recorder .....	6-3
<b>Tilt Correction Adjustment</b> .....	6-4
Tilt Sensor Zero Adjustments .....	6-4
Measuring $X_E$ .....	6-4
Fine Adjustment of $X_E$ .....	6-6
Measuring $Y_E$ .....	6-8
Fine Adjustment of $Y_E$ .....	6-9
Tilt Sensor Coarse Zero Adjustment .....	6-10
Coarse Adjustment of $X_E$ .....	6-10
Coarse Adjustment of $Y_E$ .....	6-11
Tilt Sensor Sensitivity Adjustment (TILTXS, TILTYS) .....	6-12
Measuring X-axis Sensitivity .....	6-12
Adjusting X-axis Sensitivity .....	6-13
Measuring Y-axis Sensitivity .....	6-14
Adjusting Y-axis Sensitivity .....	6-15
Tilt Sensor Cross-Coupling .....	6-16
Measuring .....	6-16
Adjusting .....	6-17
<b>Recalibrating the Gravimeter</b> .....	6-18
<b>Tripod Maintenance</b> .....	6-20
<b>Storing the Autograv</b> .....	6-20

---

## Section 7: TROUBLESHOOTING

## Section 8: REFERENCE INFORMATION

<b>Autograv Specifications</b> . . . . .	8-1
<b>Standard Accessories</b> . . . . .	8-2
<b>Optional Accessories</b> . . . . .	8-3
<b>Application Software</b> . . . . .	8-4
<b>Training</b> . . . . .	8-4
<b>Instrument Parts List</b> . . . . .	8-5
CG-3 Gravity Meter . . . . .	8-5
Options and Accessories . . . . .	8-5
<b>Spare Parts Kit</b> . . . . .	8-6
<b>Warranty and Repair</b> . . . . .	8-7
Warranty . . . . .	8-7
Repair . . . . .	8-7
When to Ship the Unit . . . . .	8-7
Description of Problem . . . . .	8-8
How to Ship the Unit . . . . .	8-8

## Appendix A: THEORY OF OPERATION

<b>Introduction</b> . . . . .	A-1
Control Console and Software . . . . .	A-5
<b>Spring Service Life and Reading Range</b> . . . . .	A-7
<b>Processing of the Gravity Signal</b> . . . . .	A-10
<b>Compensation and Corrections</b> . . . . .	A-12
Drift Correction . . . . .	A-12
Tilt Correction (TIC) . . . . .	A-13
Temperature Compensation (TEC) . . . . .	A-15
Earth Tide Correction (ETC) . . . . .	A-16
Residuals . . . . .	A-16
Gravity Offset (GREF) . . . . .	A-17

## Appendix B: ELASTIC HYSTERESIS EFFECTS

---

## Appendix C: INTERFACING WITH THE AUTOGRAV

<b>RS 232C Standard</b> . . . . .	C-1
<b>IGS Output</b> . . . . .	C-2
Serial I/O Connections . . . . .	C-2
Serial Data Format . . . . .	C-5
Text Transmission Sequence . . . . .	C-6
<b>Communication Software</b> . . . . .	C-6

## Appendix D: INITIAL CONSTANTS SHEET

### INDEX





# INSTRUMENT OVERVIEW

The Autograv is a microprocessor-based automated gravity meter that has a measurement range of over 7000 mgals without resetting and a reading resolution of 0.005 mGals (CG-3) or 0.001 mGal (CG-3M). This enables the Autograv to be used for both detailed field investigations and large scale regional or geodetic surveys.

Accurate measurements are taken by simply pressing a key, and under most conditions it takes under one minute to complete the reading. A series of readings of gravity measurements at a fixed site can be performed by setting the Autograv in the cycling mode. The Autograv obtains a reading by continuously averaging a series of one second samples. The reading is displayed on the LCD directly in mGals. The data is stored in the solid state memory and can be sent to a printer, modem, recorder or microcomputer.

The gravity sensor, solid-state control system and battery are integrated into a single instrument housing, which doubles as a carrying case. This eliminates the need for packing and unpacking the sensor between readings. Stability is increased and the risk of an accident is reduced by the absence of an external cable between the battery and sensor. The kinetic mounting system which indexes the Autograv onto the tripod further increases instrument stability.

When setting the Autograv up for a reading, the electronic tilt sensors provide greater accuracy and are easier to operate than the conventional bubble levels. The gravity meter displays the outputs from the sensors on high resolution meters on the front panel and also on the 80 character liquid crystal display.

---

## Instrument Overview

Excellent protection from changes in ambient temperature and atmospheric pressure is achieved by sealing the Autograv sensing element in a temperature stabilized vacuum chamber. The wide operating temperature of  $-40^{\circ}\text{C}$  to  $+45^{\circ}\text{C}$  (optional  $+35^{\circ}\text{C}$  or  $+55^{\circ}\text{C}$ ) enables the operator to use the Autograv in many environments. Since the sensor is made from non-magnetic fused quartz, the Autograv is not affected by magnetic field variations (as long as they are less than ten times the Earth's magnetic field, i.e.  $\pm 0.5\text{mT}$ ).

Low drift is a result of the extremely stable operating environment of the quartz elastic system. It allows the long term drift of the sensor to be accurately predicted and a real time software correction reduces it to less than 0.02 mGals per day.

Internal tilt sensors constantly supply the Autograv with information when an operator selects the continuous tilt correction feature. If measurements are taken on unstable ground, errors due to the movement of the Autograv are automatically eliminated.

An automatic tidal correction can also be selected via the keyboard. The operator enters in the geographical location and time zone information and the Autograv automatically calculates and applies a real time tidal correction to each reading.

The internal 12 volt rechargeable battery provides sufficient power to operate the Autograv throughout a normal survey day. An operator can check the battery voltage at any time by pressing a key and viewing the display. When the battery voltage is approaching the discharge level, the Autograv emits an audible alarm. An optional cable enables the instrument to operate from any external 12 volt DC power supply or battery which can supply 3 amperes peak current. In the event of a main battery failure, a set of built-in miniature batteries keeps the memory safe for several days.



Introduction

---

## Instrument Overview

**Figure 1** Autograv — The Automated Gravity Meter

# GETTING STARTED

## UNPACKING THE INSTRUMENT

The Autograv is packed in an insulated case (with the battery disconnected to comply with transport safety regulations) in order to protect the instrument during shipment.

How To

### ATTENTION:

During shipment the battery must be disconnected.

If you have just received your CG-3, the battery is fully charged, but disconnected. Please reconnect the battery (see step 6 on page 2-5) before operating

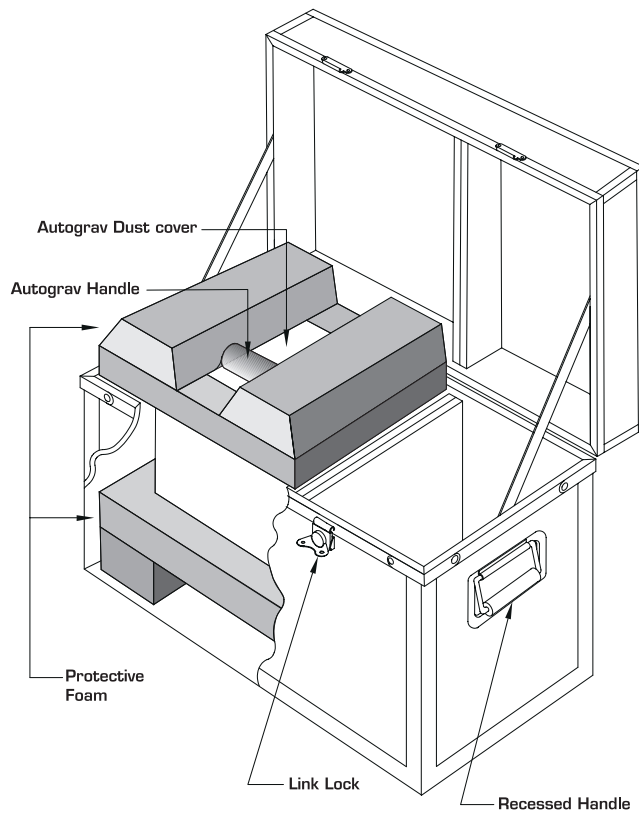

---

## Getting Started

**Figure 2** Autograv Transportation Case

### UNPACKING

1. Pull up the tab of the link lock and turn the tab *counter-clockwise* to unfasten the lock from the keeper plate.
2. Repeat step 1 for the other link lock.
3. Open the Autograv transportation case by lifting the cover.
4. Remove the protective foam from the left hand side of the transportation case to view the top of the Autograv dust cover plate.
5. Remove the Autograv from the transportation case and visually inspect for any physical damage that may have occurred during transportation.



**Important:** If there is any evidence of physical damage, *immediately* call Scintrex Limited.

6. From the right hand side of the transportation case, remove the Autograv accessories.

### REMOVING THE DUST COVER

1. Remove the dust cover plate on the Autograv by pressing down on the two latches and sliding the cover away from the instrument.
2. Place the dust cover back inside of the transportation case for safe keeping.



**Note:** If you are shipping the Autograv, *insert the dust cover* to protect the instrument.

# STARTING UP THE AUTOGRAV

Starting-up the Autograv for the first time, or after it has been turned off for more than 48 hours, requires the following steps and waiting periods.

- 1. Powering up the Autograv** —The charger powers up the instrument and also charges the battery.
- 2. Warm-up period** —After you connect the battery charger to the Autograv, it requires a 4 hour warm-up time in order to reach the operating temperature.
- 3. Stabilization period** —The instrument requires a 48 hour period after you connect the battery charger to stabilize. This is a good time to become familiar with the keypad and software. You can initialize the software by resetting the time and date, erasing the memory and setting up the Autograv parameters.

You can unplug the battery charger from the Autograv to take test readings during the stabilization period however, you must reconnect the charger after the readings are complete or if the Autograv emits the low battery alarm.

- 4. Checking and adjusting the temperature compensation** — You check and adjust the temperature compensation after the instrument is stable. (Refer to page 2-35)
- 5. Checking and adjusting the drift correction**—You check and adjust the drift correction after the temperature compensation has been checked (or adjusted if necessary). This procedure involves running the Autograv for approximately 24 hours in the cycling mode (unattended). (Refer to page 2-41)
- 6. Setting up the instrument for field operations**—You can set up your Autograv for field use after you complete the previous steps. (Refer to Section 4 - *Field Operation*)

## POWERING UP THE AUTOGRAV

1. Set the charger to the appropriate line voltage (115V or 230V) by adjusting the voltage setting switch on the charger.
2. Check the charger fuse by unscrewing the fuse holder. Each voltage setting requires a different fuse rating.

Fuses are available in the Spare Parts Kit.

Voltage	Fuse
<b>115V</b>	<b>0.75A</b>
<b>230V</b>	<b>0.375A</b>

3. After you have set the charger voltage and checked the fuse, plug the power cord of the charger into an AC outlet. The green light on the charger turns on to indicate that the charger is working.

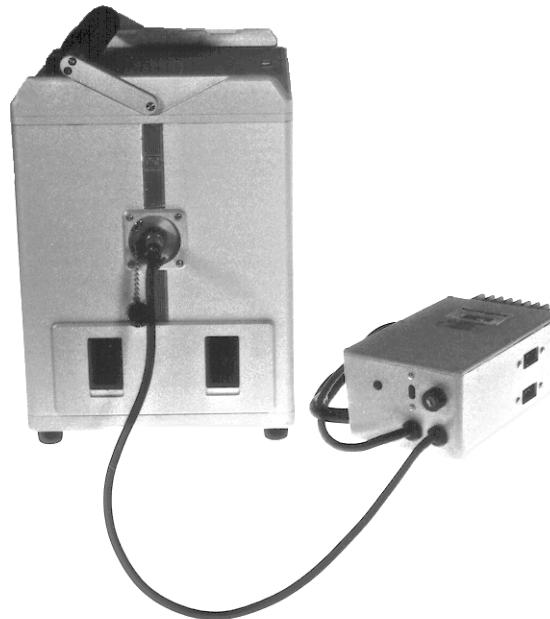

**Figure 3** Front View of the Autograv with Charger



---

## Powering up the Autograv

4. Remove the dust cap from the charger plug on the Autograv.
5. While holding the top of the instrument, insert the charger connector to the charger plug on the Autograv.
6. Open the battery compartment by pressing down on the two latches and lifting the cover away from the instrument.
7. Remove the battery by pushing on the left side of the battery and then pulling the black tab towards you so the battery can slide out of the compartment.
8. Insert the connector of the battery into either socket on the left side of the compartment. The Autograv has two sockets so that you can change batteries without powering down the instrument (see Figure 4).
9. Before you reinstall the battery, place your hand inside and flatten the black tab against the bottom, side and top of the compartment. If the black tab is not pressed against the walls of the compartment, the battery will not fit and the foam padding will be damaged.
10. Place the battery inside of the compartment with the top of the battery facing outwards and the battery cable to the left as shown in Figure 4.
11. Reinstall the battery compartment cover.

How To

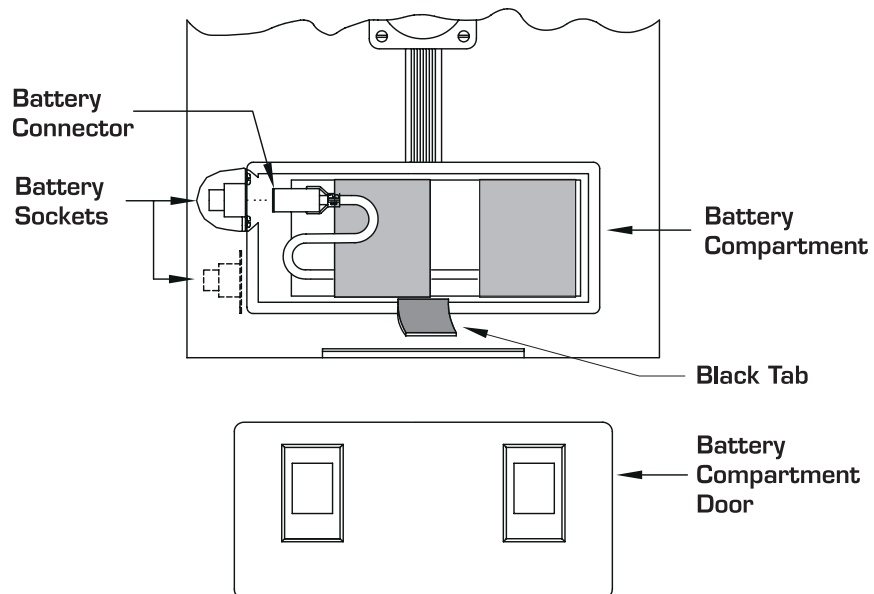

---

## Getting Started

**Figure 4** Position Of Battery Inside Compartment

## USING THE KEYPAD

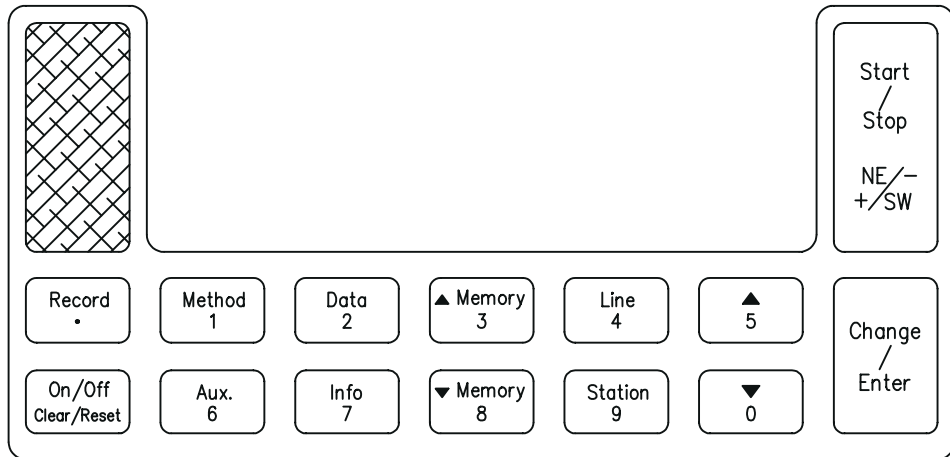

Figure 5 The Autograv Keypad

## THE KEYPAD

You can use the Autograv keypad to:

- ▲ Select menu options
- ▲ Set system parameters
- ▲ Take a reading
- ▲ Record data
- ▲ Recall stored data
- ▲ Dump data
- ▲ Reset the instrument

Each key has *two* functions. The mode of operation determines which function the Autograv responds to. The two modes of operation are:

**Operation mode**—In this mode, the key press initiates the function that is displayed at the *top* of each key.







**Enter mode**—In this mode, the key press initiates the function that is displayed at the *bottom* of each key.

## Getting Started









**Note:** If the keypad is not responding to a key press, then you need to reset the Autograv by pressing and holding the ON/OFF (  ) key for more than 5 seconds.

## Top Functions (Operations Mode)

Key	Description
	<p><b>ON/OFF</b> — Turns the instrument on and off.</p> <p>When you turn on the instrument, the previous menu option appears on the display (i.e. the status of the instrument is saved when the Autograv is turned off).</p> <p><b>Note:</b> If the instrument is busy printing, measuring or hung-up, then you must press the ON/OFF key for <i>more</i> than 5 seconds, to <i>reset</i> the instrument</p>
	<p><b>RECORD</b> — Enters measurements into memory.</p>
	<p><b>METHOD</b> — Displays the method/mode in which the instrument is currently operating.</p> <p>The selectable modes are <b>FIELD</b>, <b>CYCLING</b> or <b>NONE</b>.</p>
	<p><b>DATA</b> — Shows on the display the set of measurement parameters being measured or just completed.</p>
 	<p><b>MEMORY</b> — Recalls and displays data that is stored in memory by scrolling.</p>
	<p><b>LINE</b> — Shows the present line number and/or a line number recalled from memory (if applicable). The current line appears on the top line while the line number from memory is on the second line.</p> <p>It also enables you to change the current line number.</p>







## Using the Keypad

Key	Description
 	<p><b>SCROLL KEYS</b> — Perform two functions:</p> <ol style="list-style-type: none"> <li>1. Scroll through lists of selected data, actions or the menu options</li> <li>2. Goes to the next line or station if line or station number is displayed</li> </ol>
	<p><b>AUX</b> — Displays the <b>AUXILIARY</b> mode menu options. Use the AUX key to exit from a submenu and to return to the previous menu level.</p> <p>If you press the AUX key twice, then the software takes you from your immediate menu to the first level menu (i.e. the Main menu).</p> <p>Pressing the AUX key, while the meter is measuring, will <i>cancel</i> the measurement.</p>
	<p><b>INFO</b> — Provides remaining memory capacity, battery voltage, time and date, grid number and notebook information.</p>
	<p><b>STATION</b> — Displays the current station number and/or a station number for a measurement in memory.</p> <p>The current station appears on the top line while the station number in memory is on the second line.</p> <p>It enables you to change the current station number.</p>
	<p><b>CHANGE</b> — Enables you to select the <b>ENTER</b> mode so you can modify parameters using the bottom functions of each key.</p>

## Getting Started

Key	Description
	<b>START/STOP</b> — Enables you to: <ul style="list-style-type: none"> <li>• Start or stop a measurement</li> <li>• Start or stop the output of data to communication or recording devices</li> <li>• Start erasing and testing memory</li> <li>• Start the <b>EDIT</b> mode</li> </ul>

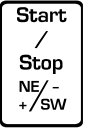
## Bottom Functions (Enter Mode)

Key	Description
	<b>CLEAR</b> — Erases the current number.
 	<b>0—9</b> — Inputs numerical data
	<ul style="list-style-type: none"> <li>• — Enters a decimal point</li> </ul>
	<b>+/-</b> or <b>NE/ SW</b> — Toggles between north, south, east, west and +/- for station and line numbers.
	<b>ENTER</b> — Enables you to: <ul style="list-style-type: none"> <li>• access the menu option shown on the display</li> <li>• to enter a selected value into memory.</li> </ul>

# THE DISPLAY

## PARAMETER SETUP DISPLAY

The Autograv display is an 80 character liquid crystal display (LCD) arranged in 4 rows of 20 digits in each row. For example:

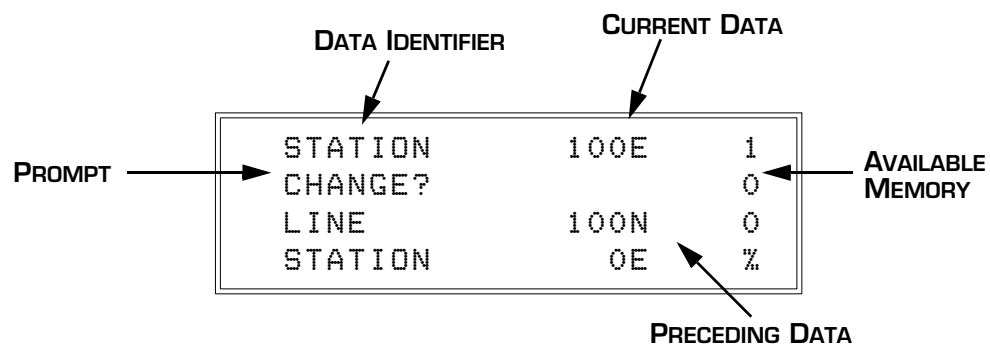

However, not all areas of the display will have information:

- ▲ If you are in the first level of menu, then there is no current or previous data so these areas will be blank.
- ▲ If you select a menu option that does not have previous data, then this area will be blank.

## MENU STRUCTURE

The Autograv has *three* levels of menus. Refer to the *Instrument Parameters* section (page 3-1) for a detailed description of the Autograv software.

### Moving Between Menus

When you press a function key in the **OPERATION** mode, you will see a menu option appear on the display.



---

## Getting Started

**Example:** Press:  AUX



```
AUTOGRAV SETUP
ENTER?
```

1. By pressing ENTER, one item of the menu list appears on the display.
2. If you want to go to the next menu option in the same level, then:  
Press:  or  (SCROLL) keys
3. If you want to go to the submenu of the displayed menu, then press the key shown on the second line of the display prompt.
4. To go back to the previous level of menu, press the  (AUX) key.

## Selecting a Menu

When the display shows the menu option that you want to select, press the key that is shown on the *second* line.

**Example:**



```
AUTOGRAV SETUP
ENTER?
```

KEY TO PRESS →  
Press:  (ENTER) key.

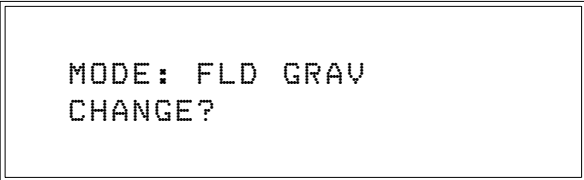









```
MODE: FLD GRAV
CHANGE?
```



KEY TO PRESS →  
Press:  (CHANGE) key



## Modifying Parameters

The prompt that is on the *second* line shows you how to change the parameter that is displayed. There are three types of prompts:

PROMPT	KEYS	TYPE
SELECT/ENTER	 or 	limited to selection
xxxx> nnn ENTER?	 to  ,  ,  (CLEAR), 	numerical values, N,S,E,W, +/-
xxxx CHG? >xxxx<	 (CHANGE)	limited to 2 selections

- ▲ If you change the parameter by using the  or  (SCROLL) keys, or change a numerical value, then you must press the ENTER key to load the change into memory.
- ▲ If you are enabling or disabling a parameter, then you do *not* have to press the ENTER key.

**Example:** To change the read time from 65 secs to 120 secs:

```

READ TIME      65
CHANGE?
    
```

Press:  (CHANGE)

```

READ TIME>65
ENTER
    
```

---

## Getting Started

Type:    (120)

```
READ TIME> 120
ENTER
```

Press:  (ENTER)

```
READ TIME      120
CHANGE?
```

---

## The Display

How To



**Figure 6** Autograv Software Flowchart For Auxiliary Mode

# INITIALIZING THE INSTRUMENT PARAMETERS









To prepare the instrument to take a reading, you must first initialize some parameters by doing the following:

- ▲ Reset time and date
- ▲ Erase memory
- ▲ Setup the Autograv parameters





**Note:** If a key is not pressed within approximately one minute, the display automatically turns *off*. However, the Autograv brings you back to the same place in the menu where you left off when you press the  (ON) key.

## 1. To Reset Time and Date

Key to Press	Display
  (AUX) twice	Current Menu
 or  until...	INITIALISE ENTER?
	Current Menu
 or  until...	TIME                    xx:xx:xx CHANGE?                xx/xx/xx
 (CHANGE)	TIME                    HH:xx:xx ENTER

## Initializing the Instrument Parameters









Key to Press	Display
HH (Value for hour)	TIME            HH:xx:xx ENTER
 (ENTER)	TIME            xx:MM:xx ENTER
MM (Value for minutes)	TIME            xx:MM:xx ENTER
 (ENTER)	TIME            xx:xx:SS ENTER
SS (Value for seconds)	TIME:            xx:xx:SS ENTER
 (ENTER)	DATE:            xx/xx/xx ENTER
<p>Repeat the steps shown above to set the current date.</p> <p>After you type the day and press the ENTER key, the clock starts to run.</p>	

How To

---

## Getting Started

### 2. To Erase Memory

Key to Press	Display
  (AUX) twice	Current Menu
 or  until...	INITIALISE ENTER?
 (ENTER)	Current Menu
 or  until...	ERASE MEMORY ENTER?
 (ENTER)	ERASE MEMORY START?
 (START/STOP)	MEMORYFREE 100% TESTED XXK

XXK is the size of the memory installed in the Autograv. For example: 48K



### 3. Autograv Setup

**Cycling and Read Time Setup**















Key to Press	Display
Aux. 6    Aux. 6 (AUX twice)	Current Menu
▲ 5    or    ▼ 0    until...	AUTOGRAV SETUP ENTER?
Change / Enter    (ENTER)	Current Menu
▲ 5    or    ▼ 0    until...	MODE:XXXX CHANGE?
Change / Enter    (CHANGE)	MODE:XXXX SELECT/ENTER
▲ 5    or    ▼ 0    until...	MODE:>CYCLING SELECT/ENTER
Change / Enter    (ENTER)	MODE:CYCLING CHANGE?
▼ 0 (SCROLL down)	READ TIME XXX CHANGE?
Change / Enter    (CHANGE)	READ TIME>XXX ENTER
Method 1    Date 2    ▼ 0 (120)	READ TIME>120 ENTER

How To















## Getting Started

### Chart Select Setup

### STOP ERR Setup

Key to Press	Display
 (ENTER)	READ TIME 120 CHANGE?
 (SCROLL down)	CYCLE TIME XXX CHANGE?
 (CHANGE)	CYCLE TIME>XXX ENTER
   (600)	CYCLE TIME>600 ENTER
 (ENTER)	CYCLE TIME 600 CHANGE?
 (SCROLL down)	CHART SELECT:XX CHANGE?
 (CHANGE)	CHART SELECT:>XX SELECT/ENTER
   un- til...	CHART SELECT:>1 ENTER
 (ENTER)	CHART SELECT: 1 CHANGE?
 (SCROLL down)	STOP:ERR,<LIM CHG?>XXXX<









## Initializing the Instrument Parameters

	Key to Press	Display
<b>CONT TILT Setup</b>	  (CHANGE until...)	STOP:ERR,<LIM CHG?>DISABLED<
	 (SCROLL down)	CAL, AFTER XX CHANGE?
	 (CHANGE)	CAL, AFTER>12 ENTER
	  (12)	CAL, AFTER>12 ENTER
<b>Auto Rejection Setup</b>	 (ENTER)	CAL, AFTER 12 CHANGE?
	 (SCROLL down)	CONT,TILT CORR, CHG?>XXXX<
	  (CHANGE until...)	CONT,TILT CORR, CHG?>DISABLED<
	 (SCROLL down)	AUTO REJECTION CHG?>XXXX<
<b>TIDE CORR Setup</b>	  (CHANGE until...)	AUTO REJECTION CHG?>SELECTED<
	 (SCROLL down)	TIDE CORRECTION CHG?>XXXX<











How To

## Getting Started

### LAT and LONG Setup

Key to Press	Display
  (CHANGE until...)	TIDE CORRECTION CHG?>SELECTED<
 (SCROLL down)	DEG. LAT XX CHANGE?
 (CHANGE)	DEG. LAT XX ENTER
Decimal degrees of the reading site  N is + (positive) S is - (negative)	DEG. LAT>DD ENTER
 (ENTER)	DEG. LAT DD CHANGE?
 (SCROLL down)	DEG. LONG XX CHANGE?
 (CHANGE)	DEG. LONG XX ENTER
Decimal degrees of the reading site  W is + (positive) E is - (negative)	DEG. LONG>DD ENTER
 (ENTER)	DEG. LONG DD CHANGE?

## Initializing the Instrument Parameters

	Key to Press	Display
<b>GMT Setup</b>	 (SCROLL down)	GMT, DIFF XX CHANGE?
	 (CHANGE)	GMT, DIFF>XX ENTER
	(GMT—Clock time) in hours  (e.g. Toronto =+5hrs or +4 during daylight savings time)	GMT, DIFF>HH ENTER
<b>AUTO RECORD Setup</b>	 (ENTER)	GMT, DIFF HH CHANGE?
	 (SCROLL down)	AUTO RECORD CHG?>XXX<
<b>REF Setup</b>	  (CHANGE until...)	AUTO RECORD CHG?>DISABLED<
	 (SCROLL down)	REF, XX CHANGE?
	 (ENTER)	REF, >XX ENTER
	 (0)	REF, >0 ENTER
	 (ENTER)	REF, 0 CHANGE?

How To









## Getting Started

### DRIFT CORR Setup

Key to Press	Display
<div style="border: 1px solid black; padding: 2px; display: inline-block;">▼ 0</div> (SCROLL down)	DRIFT CORRECT, ENTER?
<div style="border: 1px solid black; padding: 2px; display: inline-block;">Change / Enter</div> (ENTER)	Current Menu
<div style="border: 1px solid black; padding: 2px; display: inline-block;">▲ 5</div> or <div style="border: 1px solid black; padding: 2px; display: inline-block;">▼ 0</div> until...	DRIFT XX CHANGE?
<div style="border: 1px solid black; padding: 2px; display: inline-block;">Change / Enter</div> (CHANGE)	DRIFT>XX ENTER
Numerical value (From constant sheet or most recent value)	DRIFT>VV ENTER
<div style="border: 1px solid black; padding: 2px; display: inline-block;">Change / Enter</div> (ENTER)	DRIFT VV CHANGE?
<div style="border: 1px solid black; padding: 2px; display: inline-block;">▼ 0</div> (SCROLL down)	CHG. START TIME ENTER?
<div style="border: 1px solid black; padding: 2px; display: inline-block;">Change / Enter</div> <div style="border: 1px solid black; padding: 2px; display: inline-block;">Change / Enter</div> (CHANGE) twice	CHG. START TIME ENTER?
The drift correction start time is now set to the current time and date on the clock.	
<div style="border: 1px solid black; padding: 2px; display: inline-block;">Aux. 6</div> (AUX)	DRIFT CORRECT, ENTER?

## Initializing the Instrument Parameters

### Initial Constants Setup

Key to Press	Display
 (SCROLL down)	INIT, CONST, ENTER?
 (ENTER) and then  or  (SCROLL) until...	GCAL, 1 XX CHANGE?
 (CHANGE)	GCAL, >XX ENTER
<p>Enter the <i>numerical value</i> from the <b>INSTRUMENT CONSTANTS</b> sheet. (Every instrument has its own set of initial constants. These <i>must match</i> the parameters setup in the <b>INITIAL CONSTANTS</b> mode.)</p>	
 (ENTER)	GCAL, 1 XX CHANGE?
 (SCROLL down)	GCAL, 2 XX CHANGE?
<p>Follow the key press steps (as shown in the previous four steps) for all <i>five</i> of the initial constants and set the values to match the instrument's individual constants sheet values.</p>	
 (Aux)	INIT, CONST, ENTER?
 (SCROLL down)	MODE: CYCLING CHANGE?
<p>You are now back to the top/start of the AUTOGRAV SETUP submenu.</p>	



## THE DISPLAY DURING READINGS

After you press the **START** key to initiate a reading, the display goes through two display changes to enable you to level the Autograv before you actually start a reading.

The *first* display indicates that the Autograv is in the **ADJUST** mode. Within a few seconds, the display changes to show you the values of the **X** and **Y** tilts, as follows:

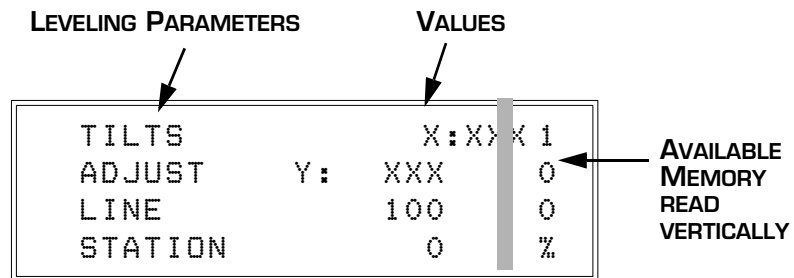

To level the instrument, read the display and analog tilt meters, and then adjust the tripod until the Autograv is level.



---

### The Display during Readings

Press the START key to start the reading. The display then goes into the **PAUSE** mode to enable the instrument to settle after the button is pushed. Within a few seconds, the gravity reading appears on the *second* display as follows:

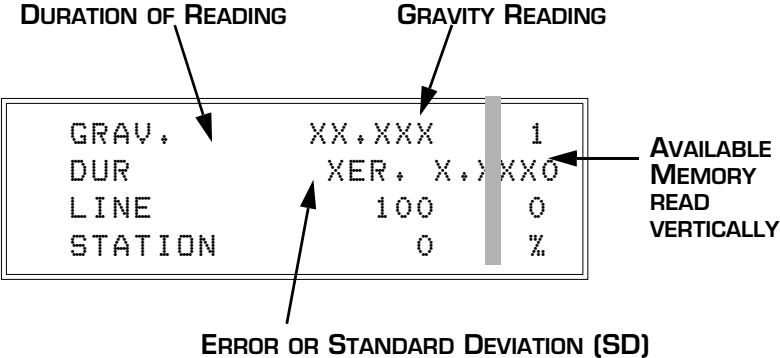

How To

# SETTING UP THE TRIPOD

The tripod enables you to level the Autograv before taking a reading. The three leveling screws on the bottom of the tripod are adjusted until the X and Y meters on the front panel of the Autograv and the display show that the Autograv is level.

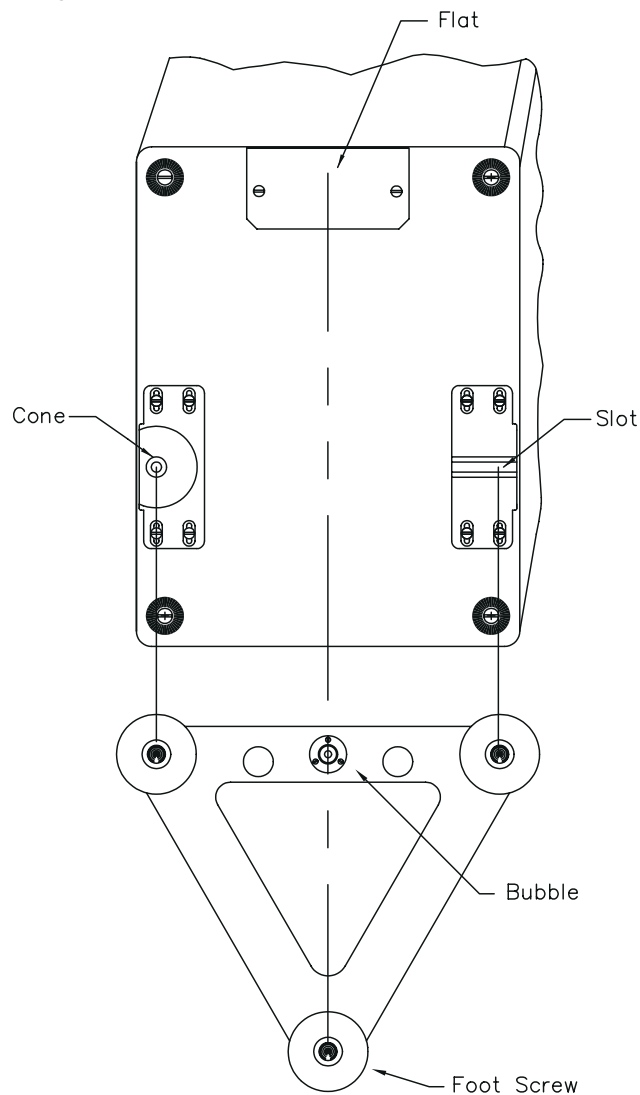

**Figure 7** Setup of the Tripod

---

## Setting up the Tripod

### To set up

1. Set the tripod on stable ground in a quiet location with the bubble level away from you as shown in the previous diagram (Figure 7).
2. Place the cone on the bottom of the instrument (left side) down onto the left rear tripod foot.
3. Place the slot on the bottom of the instrument (right side) down onto the right rear tripod foot.
4. Lower the instrument onto the front tripod foot.
5. Press the START key.



The following prompts appear one after the other:

```
AUTOGRAV  
ADJUST
```

```
TILTS      X: XXX  
ADJUST     Y: XXX
```

6. View the X and Y meters on the front panel and the display to level the instrument.

## Getting Started

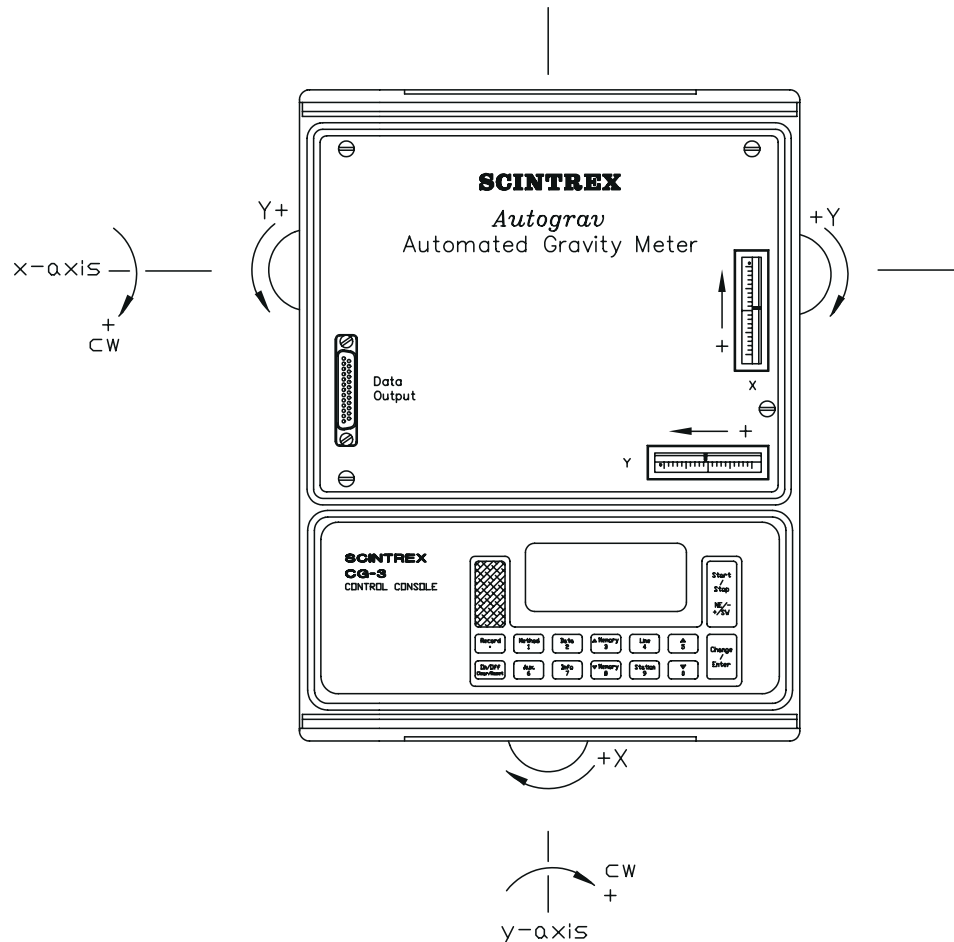

**Figure 8** Adjusting the Tripod

### To Level

You have two options for leveling the Y-axis of the CG-3/3M. The fastest way to level the meter is to adjust both rear screws on the tripod as outlined in Step 7. The other option for high precision microgravity measurements is to set one of the rear screws in the middle of its range and tape over it. Adjust the other rear screw until the Y-axis is level. This method ensures that the elevation of the CG-3/3M sensor relative to the tripod is strictly maintained.

---

## Setting up the Tripod

7. Adjust the Y-axis first by turning the two rear screws on the tripod and viewing the display and bubble meters.

If you need to level the Y-axis in the *positive* direction, then turn the rear screws towards the front of the instrument. (See Figure 8 above.) This procedure of rotating both screws in *opposite* directions at the same time is the most efficient way to level about the Y-axis.

8. After the Y-axis is level, adjust the X-axis by turning the front screw on the tripod and viewing the display and bubble meters.

If you need to level the X-axis in the *positive* direction, then turn the front screw *clockwise*. (See Figure 8 on page 2-32.)

## TRIPOD EXTENDER LEGS

The tripod comes with three extender legs which may be used under soft soil conditions.

### To set up

1. Place one extender leg over one of the pointed bottom legs of the tripod with the tab of the extender leg facing the outside of the tripod. This tab is available so that you can step on the tab to dig the shaft of the leg into the soil.
2. Insert the 8-32 hex bolt through the openings of the legs. Ensure that the head of the nut fits into the recessed slot on the extender leg as this enables you to securely tighten the bolt.
3. Place the washer and the black wing nut onto the bolt and slightly tighten the wing nut.
4. Adjust the angle of the extender leg and tighten the wing nut.
5. Repeat steps 1 through 4 for the other two extender legs.

---

**Getting Started**

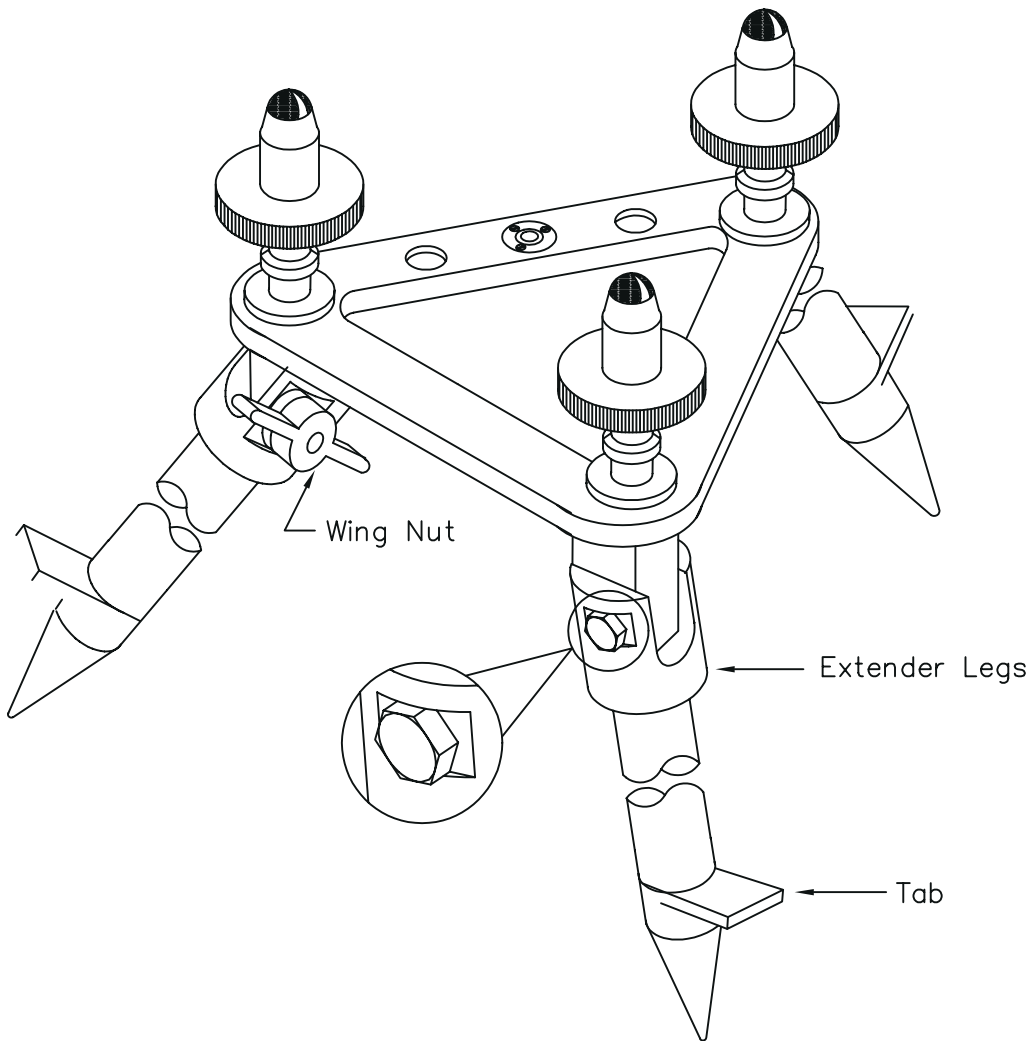

**Figure 9** Tripod with Extender Legs

# TEMPERATURE COMPENSATION



**Important:** Do not adjust the temperature compensation until the Autograv has gone through the complete stabilization time of 48 hours. If you can not wait for 48 hours, then please refer to “Using the CG-3 before Warm-up Stabilization is Complete” on page 4-10.

## CHECKING

1. Select a stable base for the Autograv in a quiet location and place the instrument on the tripod (with extender legs removed).
2. Level the Autograv by following the steps outlined in “Setting up the Tripod” on page 2-30.
3. When the following prompt appears,

How To

```
TILTS      X: XXX  
ADJUST Y: XXX
```

press the  (SCROLL DOWN) key. The following prompt appears:

```
TEMP. X.XX  
ADJUST
```

- a. If the number on the top line of the display is between  $+1.0$  and  $-1.0$ , then the temperature of the gravity sensor is within range. Please proceed to the section “Adjusting Drift Corrections” on page 2-41.
- b. If the temperature value is outside of the acceptable range, you must adjust the temperature compensation offset.

---

## Getting Started

### ADJUSTING TEMP. COMPENSATION OFFSET

1. Using a slot-head screwdriver, unscrew the four 4-40 oval screws from the faceplate of the Autograv.
2. Remove the faceplate.

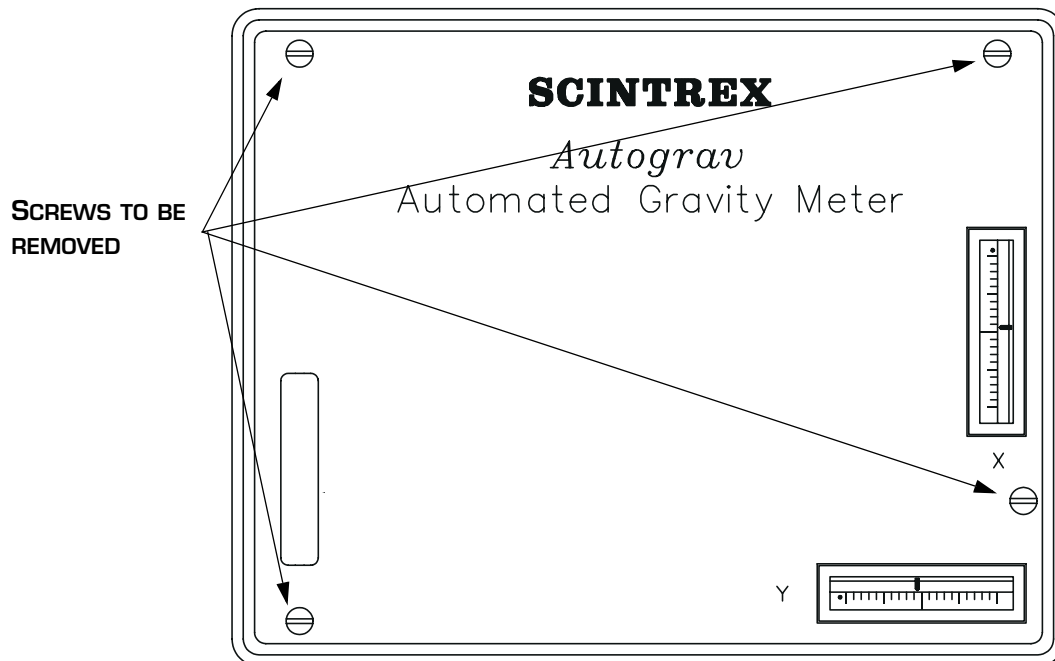

**Figure 10** Faceplate of Autograv



---

## Temperature Compensation

How To

---

**Getting Started**

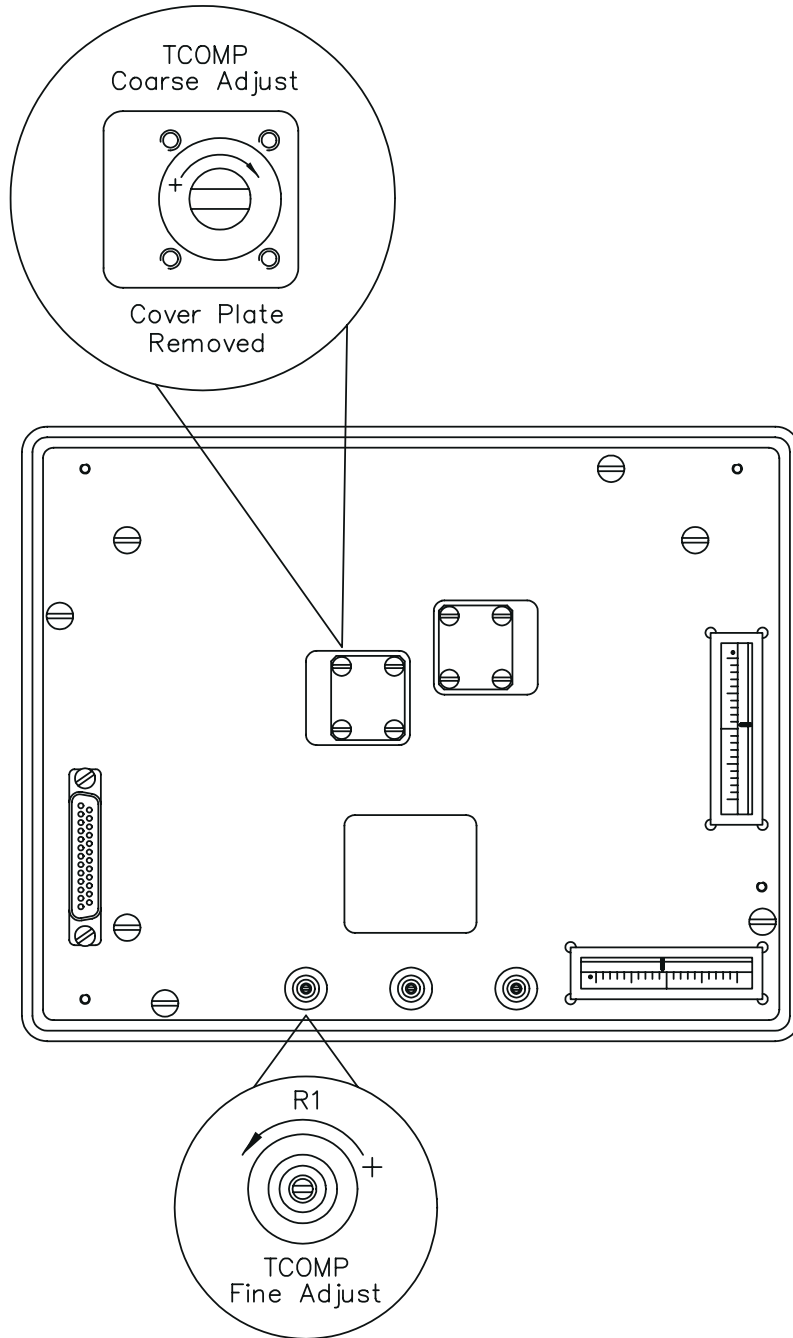

**Figure 11** Autograv Faceplate Removed

---

## Temperature Compensation

### To Adjust

Adjust the *Temperature Compensation Fine Adjustment Potentiometer (R1)* until the display is close to  $0.0$  (i.e. within the range of  $-0.1$  to  $+0.1$ .)



**Counter-clockwise = positive**

If the temperature value adjusts to this range, then replace the cover.

**If the temperature value cannot be adjusted to be within the specified range, then:**

1. Centre **R1** by turning the potentiometer *clockwise* 25 turns followed by 10 turns *counter-clockwise*.
2. Using a slot head screwdriver, remove the four *M2.5 x 5mm* flat head screws from the *Temperature Coarse Adjustment* cover.
3. Underneath the cover is an O-ring seal. This ensures that no moisture or dust can enter into the adjustment pot. Remove the O-ring seal and place it in a dry, clean place. (See Figure 11 on page 2-38.)
4. View the position of the *Coarse Adjustment* screw. You only need to slightly move the screw to make an adjustment.

**BEFORE TURNING THE SCREW, CAREFULLY NOTE ITS POSITION.**

**Clockwise = positive**

**Counter-clockwise = negative**

After making a very small adjustment of a few degrees, wait several seconds for the system to stabilize before reading the temperature value.

**Note:** *Do not push down on the coarse adjust screw, as this could damage the adjustment potentiometer.*

5. Adjust the *Coarse Adjustment Screw* to bring the temperature reading to as close to zero ( $0.0$ ) as possible.
6. Adjust the *Fine Adjustment* potentiometer until the reading is within the range of  $-0.1$  to  $+0.1$ .
7. Wait a few minutes and then check the reading.



---

## Getting Started



8. Readjust the *Fine Adjustment* potentiometer, if necessary.

**Note:** If the reading does not come within the range with a coarse adjustment of 1 turn in either direction, contact Scintrex Limited.

9. Replace the cover(s).

# ADJUSTING DRIFT CORRECTIONS



**Important:** You must first check and adjust the temperature compensation before you can adjust the drift correction.

## 1. Measure Drift

1. After you adjust the temperature compensation, press the  (SCROLL DOWN) key to display the **X** and **Y** Tilts.
2. Level the instrument (using the tripod setup procedures) to within -10 to +10 arcseconds about both axis.  
*Level the Y-axis, rear footscrews, first.*
3. Press the **START** key. The instrument starts a reading.

If the reading appears to be out of range (top line of display) refer to unlatching the sensor on page 7-1 of the *Troubleshooting* section.

4. The Autograv now automatically takes and records a reading once every 600 seconds.
5. After approximately 24 hours, press the **STOP** or **AUX** key if the instrument is taking a measurement. Otherwise, press the **STOP** key. This stops the reading cycle.

If any of the **DATA**, **INFO** or **SCROLL** keys are pressed, then the display will appear to be locked-up. You must then press and hold the **ON** key for more than 5 seconds to reset the instrument.

If any other key is pressed while the meter is in the **OFF** stage of the **CYCLE** mode, then you must press the **STOP** key to stop cycling.

6. Output the data to a printer or computer.

## Getting Started

### 2. Output Data



1. Press the (AUX) key



2. Press the or (SCROLL) key until the following prompt appears:

```
OUTPUT
ENTER?
```

**Note:** You must setup the baud rate, data bits and carriage return of the printer before you dump data. Refer to the *Instrument Parameter Section*, starting on page 3-37, on how to set these parameters.



3. Press the ENTER key. The following prompt appears:

```
AUTOGRAV
START DUMP
```



4. Press the START key.

#### Example

The following is a sample printout of output data:

```
-----
SCINTREX V4.1      AUTOGRAV / Cycling Mode      R4.4
Cycle Time:      150
Line: 2.  Grid:  0.  Job:  0.  Date: 95/05/08  Ser No:  8267.
Operator:  0.

GREF.:          -4158. mGals          Tilt x sensit.:  296.5
GCAL.1:         6131.436             Tilt y sensit.:  283.8
GCAL.2:         0.                   Deg.Latitude:   43.7
TEMPCO.:        -0.1241 mGal/mK     Deg.Longitude:  79.6
Drift const.:   0.18                 GMT Difference:  4.hr
Drift Correction Start Time: 11:57:16  Cal.after x samples: 12
Date: 95/04/13                       On-Line Tilt Corrected = "*"
-----
DRIFT → Station  Grav.  SD.  Tilt x  Tilt y  Temp.  E.T.C.  Dur  # Rej  Time
R1,T1 →  0.    41.684  0.041  2.    -2.    -0.69  -0.023  120  0  14:03:57
          0.    41.685  0.037  1.    -3.    -0.67  -0.023  120  0  14:06:27
          0.    41.684  0.044  2.    -3.    -0.65  -0.023  120  1  14:08:57
-----
```

## Adjusting Drift Corrections

0.	41.683	0.031	1.	-3.	-0.65	-0.023	120	0	14:11:27
0.	41.682	0.036	1.	-3.	-0.65	-0.024	120	0	14:13:57
0.	41.682	0.034	1.	-3.	-0.64	-0.024	120	0	14:16:27
0.	41.680	0.033	2.	-3.	-0.64	-0.024	120	0	14:18:57
0.	41.682	0.045	2.	-3.	-0.64	-0.024	120	0	14:21:27
0.	41.681	0.036	2.	-3.	-0.64	-0.024	120	1	14:23:57
0.	41.681	0.038	1.	-3.	-0.64	-0.023	120	0	14:26:27
0.	41.683	0.038	1.	-3.	-0.64	-0.023	120	0	14:28:57
0.	41.679	0.042	1.	-4.	-0.63	-0.023	120	0	14:31:27
0.	41.681	0.034	1.	-4.	-0.64	-0.023	120	0	14:33:57
0.	41.682	0.043	2.	-3.	-0.64	-0.023	120	0	14:36:27
0.	41.680	0.035	2.	-3.	-0.64	-0.023	120	0	14:38:57
0.	41.681	0.037	2.	-3.	-0.64	-0.023	120	0	14:41:27
0.	41.679	0.037	2.	-3.	-0.63	-0.023	120	0	14:43:57
0.	41.682	0.032	2.	-3.	-0.63	-0.023	120	0	14:46:27
0.	41.683	0.039	2.	-3.	-0.63	-0.023	120	0	14:48:57
0.	41.681	0.039	2.	-3.	-0.64	-0.023	120	0	14:51:27
0.	41.679	0.049	2.	-3.	-0.64	-0.022	120	0	14:53:57
0.	41.679	0.039	2.	-3.	-0.64	-0.022	120	0	14:56:27
0.	41.678	0.038	2.	-3.	-0.64	-0.022	120	0	14:58:57
0.	41.682	0.040	2.	-3.	-0.63	-0.022	120	0	15:01:27
0.	41.681	0.038	2.	-3.	-0.64	-0.022	120	0	15:03:57
0.	41.680	0.042	2.	-3.	-0.63	-0.022	120	0	15:06:27
0.	41.679	0.044	2.	-3.	-0.63	-0.021	120	0	15:08:57
0.	41.680	0.040	2.	-3.	-0.63	-0.021	120	0	15:11:27
0.	41.684	0.038	2.	-3.	-0.63	-0.021	120	0	15:13:57
0.	41.678	0.039	2.	-3.	-0.63	-0.021	120	0	15:16:27
0.	41.681	0.036	2.	-3.	-0.63	-0.020	120	0	15:18:57
0.	41.681	0.043	2.	-3.	-0.63	-0.020	120	0	15:21:27
0.	41.681	0.041	2.	-3.	-0.63	-0.020	120	0	15:23:57
0.	41.680	0.044	2.	-3.	-0.63	-0.020	120	0	15:26:27
0.	41.682	0.040	2.	-3.	-0.63	-0.019	120	0	15:28:57
					.				
					.				
					.				
					.				
0.	41.749	0.039	1.	-3.	-0.63	-0.016	120	0	01:51:27
0.	41.742	0.037	2.	-3.	-0.63	-0.016	120	0	01:53:57
0.	41.743	0.044	2.	-3.	-0.63	-0.016	120	0	01:56:27
0.	41.741	0.041	1.	-3.	-0.63	-0.015	120	1	01:58:57
0.	41.749	0.041	1.	-3.	-0.63	-0.015	120	0	02:01:27
0.	41.749	0.040	1.	-3.	-0.63	-0.014	120	0	02:03:57
0.	41.745	0.031	1.	-3.	-0.63	-0.014	120	0	02:06:27

R2,T2 →

How To

### 3. Reading the Data

1. From the listing, take one reading (**R1**) at time **T1** close to the start of the recording period and another reading (**R2**) at time **T2** from near the end of the period.

Do not use readings which are obviously noisy or disturbed.

2. From these values, calculate a new *Drift Correction*.

$$\text{DRIFT}' = \text{DRIFT} + \left[ \frac{\text{R2} - \text{R1}}{\text{T2} - \text{T1}} \right]$$

---

## Getting Started

where:

**DRIFT** is the Drift constant in the instrument during readings  
(**T2-T1**) is in units of *days*.

**Example:** The data from the printout on page 2-42 was used to calculate the following drift value.

Selecting: **T2** = 02:03:57 on 95/05/09  
**T1** = 14:03:57 on 95/05/08

Gives the corresponding readings:

**R2** = 41.749  
**R1** = 41.684

and **DRIFT** = 0.18 (from the dump's header: **Drift const.**)

**R2 - R1** = 0.065mGal  
**T2 - T1** = 12 hrs = 0.50 days



Therefore,

$$\mathbf{DRIFT'} = 0.18 + \left[ \frac{0.065}{0.5} \right]$$

**DRIFT' = 0.31 mGal/day**

## 4. Adjusting the Drift Correction



1. Press the **AUX** key twice and then the  or  (**SCROLL**) key until the following prompt appears:





2. Press the **ENTER** key.

AUTOGRAV  
SETUP ENTER?



## Adjusting Drift Corrections

3. Press the  or  (SCROLL) key until the following prompt appears:





```
DRIFT CORRECT,  
ENTER?
```



4. Press the ENTER key.



5. Press the  or  (SCROLL) key until the following prompt appears:

```
DRIFT XX  
CHANGE?
```



6. Press the CHANGE key.

7. Type: The new calculated drift value (**DRIFT**).



8. Press the ENTER key.



With a new instrument, check the *Drift Correction* once a week for 4 weeks. After this period, check approximately once a month. For most sensors, the drift rate will go down as they age, especially during the first couple of months. Please also note that the drift correction start time is automatically reset to zero after 128 days since the last adjustment — giving rise to an apparent large offset. Therefore, you must reset the drift correction start time before 128 days have elapsed.

# SETTING UP FOR FIELD MEASUREMENTS



1. Press the AUX key and then the  key until the following prompt appears.

```
MODE: CYCLING  
CHANGE?
```



2. Press the CHANGE key.



3. Press the  key until the following prompt appears.

```
MODE: > FLD GRAV  
SELECT/ENTER
```



4. Press the ENTER key.

5. The reading time (120 seconds) may be too long for normal field operation, however it can be shortened 60 seconds (see the *Instrument Parameters* and *Field Operation* sections).





6. Take a reading by pressing the START key once to get into the **ADJUST** mode.

7. Re-level the Autograv.



8. Press the START key again.

## RECALLING DATA

- ▲ When the Autograv records a measurement, all information associated with that measurement (i.e. measured data, line and station numbers, notebook information, time and date) are filed together in a single record.
- ▲ For every measurement taken at each station, the Autograv creates a new, separate record.
- ▲ The Autograv enables you to scan these records using either of the  or  (MEMORY) keys.

## SCROLLING IN MEMORY

In memory, you can scroll from station to station, from line to line or from grid to grid. The two MEMORY keys enable you to scroll sequentially through the stations on a line, through the lines of the survey or through the grids of the survey.

Various data recorded from one station can also be examined. The two scroll keys enable you to scroll through the data or notebook information at a particular station.







**Note:** This information is for recalling data in the **FIELD** mode for the *day* on which it was recorded.

To recall data from previous days or to recall data in the **CYCLING** mode, refer to pages 2-48 to 2-51.

## SCANNING THE RECORDS













To search through the memory do the following:

1. Return to the first level of menus in the **AUXILIARY** mode.
2. If the data is recorded using the **FIELD** and **CYCLING** modes, then select the method that you want to examine (see page 3-xx).
3. Press one of the following keys:



- ▲  DATA — for recorded time and measured data
- ▲  STATION — for station numbers
- ▲  LINE — for line numbers
- ▲  INFO — for current time, date and notebook information or for grid numbers

4. Press one of the memory keys to enter the **MEMORY** mode. The upper line of the display shows the current information, while the second line shows the information stored in the memory. The prompt **MEMORY** indicates the stored information.

### Notes:



- ▲ If the grid number is displayed ( INFO key and  or  ), by pressing the memory keys, the records with the current station but with larger grid numbers ( MEMORY) or smaller grid numbers ( MEMORY) are accessed. By subsequently pressing the  DATA or  INFO keys their respective records will be recalled for display.
- ▲ If the line number is displayed, by pressing the MEMORY keys, the records with the current station but with larger line numbers ( MEMORY) or smaller line numbers ( MEMORY) are accessed. By subsequently pressing the  DATA or  INFO keys their respective records will be recalled for display.
- ▲ If the station number is displayed, by pressing the memory keys, the records with the current line number with larger station numbers ( MEMORY) or smaller station numbers ( MEMORY) are accessed.

## Recalling Data





- ▲ If the **DATA** or **INFO** is displayed, by pressing the MEMORY keys, the same parameters are displayed for the current line numbers but for station numbers that are larger ( MEMORY) than the current station number or smaller ( MEMORY) than the current station number.

The following signs appear on the second line to show you where you are in the memory:

Sign	The data is from a station number:
+	<i>higher</i> than the current station
=	<i>equal</i> to the current station
-	<i>lower</i> than the current station

The message **NO STN** or **NOLINE** (or a similar message) indicates that there is no data for the station, line or grid number with the number larger ( Memory) or smaller ( Memory) than currently being examined.



5. Use the ( ) MEMORY keys to scroll through the records. Use the ( ) SCROLL keys to examine data in a particular record.

---

## Getting Started

### DIRECTLY ACCESSING A RECORD FROM MEMORY

You can directly access a record instead of using the scrolling method described previously, by doing the following:

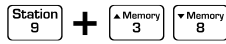

1. Press the STATION key and then one of the MEMORY keys.

2. Enter the required station number by doing the following:



Press: CHANGE/ENTER

Enter: Station number and Direction



Press: CHANGE/ENTER

**Note:** The entry appears on the second line.

3. If the station is on a different line, then do the following:



Press: LINE key



Press: CHANGE/ENTER

Enter: Line number



Press: CHANGE/ENTER











4. Press: DATA key

5. Examine the data for the record.





## RECALLING DATA IN THE CYCLING MODE

The procedure is basically the same as in the Field Mode except that the data is stored under the same station and line.

1. To view the data for the current day do the following:

 Press: DATA key  
 OR  Press:  or  MEMORY key to scroll through *records* (stored in the same order in which they were made)  
 OR  Press:  or  to scroll through the *parameters* of a particular record.

2. To view the data from a previous day do the following:

 Press: LINE key  
 Press:  MEMORY key to get the data from the *previous day* (pressing it again will take you back another day for each press, etc.) The displayed line number does not change during these operations.  
 Press: DATA key to access the *records* of the selected day.

## EXITING FROM THE MEMORY MODE

There are two ways to exit from the memory mode:

1. Press the ON/OFF key  

or,

2. Press the START key to start a new measurement.  

---

## Getting Started



# INSTRUMENT PARAMETERS





The Autograv operation is controlled through the keyboard accessed firmware functions. The software programs are permanently stored in EPROM (erasable programmable memory) chips and are called *firmware*. There are two sets of EPROM chips:

- ▲ Data acquisition system (DAS) firmware chips (current version V4.1)
- ▲ Autograv measurement control firmware chips (current version R4.4)

The firmware version of each set is indicated on the first line of the data dump (page 3-31).

The Autograv software is accessed using the keys on the keypad. The **AUXILIARY** mode displays the main menu of the Autograv.

## MAIN MENU (AUXILIARY MODE)

1. You can access the **MAIN MENU** by pressing the  AUX key.
2. To scroll through the first level of menus, simply press the  or  keys.
3. In the **AUXILIARY** mode there are three levels of menus. To enter a submenu, you follow the instructions given by the prompt that is displayed on the *bottom* line of the display.
4. To return to the previous menu level, you must press the  AUX key.

Please refer to the software flowchart (Figure 6 on page 2-17) to view all of the menu levels. A description of each parameter is given in the pages following the **AUXILIARY** mode software flowchart.

---

## Instrument Parameters

**Notes:** **Auto-shutoff** —If you do not use the Autograv for one minute, the display automatically turns off. Press the  ON key to return to the menu selection where you had previously left the instrument.

**Sub-menu data entry**—If you have selected a submenu (by pressing the key shown in the prompt on the bottom of the display), but have *not* entered in new data, then you must either:



- ▲ press the ENTER key to leave the data as it is,
- ▲ or enter in new data and then press the ENTER key.

**Returning from sub-menus**—Press the  AUX key to return to the previous menu.

# AUXILIARY MODE

There are seven main menu options in the **AUXILIARY** mode:

1. INITIALISE
2. LIN SEP
3. STN SEP
4. AUTOGRAV SETUP
5. OUTPUT
6. EDIT
7. LOCK AUX

# INITIALISE MENU

There are twelve submenus in the **INITIALISE** mode. These menus, if selected, require you to input specific data.



1. To enter into the **INITIALISE** submenus, press the ENTER key and a submenu appears:

Example:

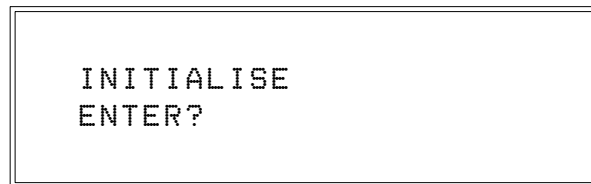

Press: ENTER key



2. To enter into the submenu level, follow the prompt that is shown on the second line of the display.
3. To return to the previous level of menu, press the AUX key.



**Note:** If you have selected a submenu (by pressing the key shown in the prompt on the display), but have not entered in new data, then you must press the ENTER key to leave the data as it is or enter in new data and then press the ENTER key. You may then press the AUX key to return to the previous menu.

## INITIALISE SUBMENUS

The steps involved to enter a submenu are shown starting from the **INITIALISE** menu. If you are already in the submenu level, then follow the steps starting from step 2.

---

## Instrument Parameters

### 1. ERASE MEMORY





At the start of each survey day ensure that there is adequate storage space for the day's data. The amount of memory available is displayed on the right hand side of the screen (or by pressing the INFO key). If there is insufficient capacity available, then erase the memory.



Erasing the memory does not erase initialization, setup or position parameters. However, all the recorded measurements in the memory will be lost. Please ensure that you have transferred the data to your computer or printed them out.

To erase the memory, do the following:



1. Display the INITIALISE prompt and press the ENTER key.
2. Scroll through the submenus by pressing the  or  key until the following prompt appears:

```
ERASE MEMORY
ENTER?
```



3. Press the ENTER key. The following prompt appears:

```
ERASE MEMORY
START?
```



4. Press the START key. The prompt TESTING appears.
5. When the memory is erased the following message appears:

```
MEMORY FREE 100%
TESTED 48K
```



## INITIALISE Menu

The 48K represents the size of memory installed in the Autograv. If the value in the display does not agree with the installed value, then there has been a partial memory failure.

### 2. JOB NO.

This submenu allows you to set a job number as shown in the following steps:



1. Display the INITIALISE prompt and press the ENTER key.
2. Scroll through the submenus by pressing the  or  key until the following prompt appears:

```
JOB NO.      X
CHANGE?
```



3. Press the CHANGE key.
4. Key in the new job number





5. Press the ENTER key.

### 3. OPERATOR

This submenu allows you to set an operator number as shown in the following steps:



1. Display the INITIALISE prompt and press the ENTER key.
2. Scroll through the submenus by pressing the  or  key until the following prompt appears:

```
OPERATOR     X
CHANGE?
```

---

## Instrument Parameters



3. Press the CHANGE key.
4. Key in the new operator number.





5. Press the ENTER key.

### 4. GRID

This submenu allows you to set a grid number, as shown in the following steps:

**Note:** You can also set this parameter by:  
pressing the  INFO key on the keypad,  
scrolling through the menu to the GRID prompt  
and following the same steps as outlined below in steps 3 to 5.



1. Display the INITIALISE prompt and press the ENTER key.
2. Scroll through the submenus by pressing the  or  key until the following prompt appears:

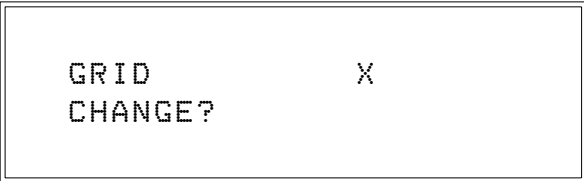

```
GRID          X
CHANGE?
```



3. Press the CHANGE key
4. Key in the new grid number



5. Press the ENTER key.

### 5. LINE DIR

This submenu enables you to set the *direction* in which the lines are running on the grid. You can choose from the following selections:



- ▲ E/W
- ▲ N/S
- ▲ +/-

## INITIALISE Menu

**Example:** If you select E/W, then a line is identified as north or south of zero and a station (along a specific line) as east or west of zero.



To select a line direction, do the following:



1. Display the INITIALISE prompt and press the ENTER key.
2. Scroll through the submenus by pressing the  or  key until the following prompt appears:

```
LINE DIR      XX
CHANGE?
```



3. Press the CHANGE key.
4. Press the  or  key until the desired direction appears on the display.



5. Press the ENTER key.

**Note:** The line and station data are recorded as *positive* and *negative* numbers in the memory. The selection E/W or N/S is a filter which only modifies the presentation of the data for display or output. This is done by assigning either N or E for the *positive* lines (or stations) as specified by the current setting. For example, a station record as +100 will be output as 100E, if the line direction setting is not changed. However, if the setting is changed to N/S *before* the data is output, then the same station will appear as 100N.



**Important:** It is recommended that you do not change the line direction setting before the data has been output and the memory has been erased.

## 6. LINE

You can enter the line number that is to be surveyed first on the survey day.



---

## Instrument Parameters

**Note:** You can also set this parameter by pressing the  LINE key on the keypad and following the same steps as outlined below in steps **3** to **5**.

To set the first line number do the following:



1. Display the INITIALISE prompt and press the ENTER key.
2. Scroll through the submenus by pressing the  or  key until the following prompt appears:

```
LINE           X
CHANGE?
```



3. Press the CHANGE key
4. Key in the first line number.



5. Press the ENTER key.

## 7. STATION



At the start of a survey day you should enter in the first station number before taking a measurement.



**Note:** You can also set this parameter by pressing the  STATION key on the keypad and following the same steps as outlined below in steps **3** to **5**.

To set the first station number do the following:



1. Display the INITIALISE prompt and press the ENTER key.
2. Scroll through the submenus by pressing the  or  key until the following prompt appears:

```
STATION       X
CHANGE?
```





3. Press the CHANGE key.
4. Key in the first station number.



5. Press the ENTER key.

## 8. AUTO STN INC

You can set the Autograv so that it automatically increments to the next station after a cycle of survey measurements is recorded. Refer to the first level menu of `STN SEP`.

To set the Automatic station increment feature, do the following:



1. Display the INITIALISE prompt and press the ENTER key.
2. Scroll through the submenus by pressing the or key until the following prompt appears:

```
AUTO STN INC
CHG? >nnnnnn<
```



3. Press the CHANGE key to alternately choose either `DISABLED` or `SELECTED`.
4. Press the or key to scroll to the next submenu.

When the measurement for a station has been recorded, the station number is displayed along with the prompt `CHG?`. In the lower line of the display, the number of the station where the measurements were just taken is shown. Depending upon whether the *Auto Station Increment* was selected or disabled, the upper line displays either the next station number or the one just measured, respectively.

### a) Automatic Station Increment - Selected



If you select the *Automatic Station Increment* feature, after you press the RECORD key, then the station number automatically increments to the next station number after each measurement is recorded. However,



## Instrument Parameters

you must ensure that the station separation parameter (STN SEP) reflects the direction of travel. During a survey, you might walk up one line and down the next. To accommodate this change of direction, the station separation must be changed also.

**Example:** When walking north (or east, or +), a station separation of 100N (or E, or +) will increment the station number by 100 with each recorded measurement. Walking down the next line, you will be traveling south (or west, or -). For the automatic incrementation to work properly, the station separation must be set to 100S (or W, or -) so that the station numbers will now decrement.

### b) Automatic Station Increment - Disabled

If you disable the *Automatic Station Increment* feature, you must manually increment the Autograv to the next station by using one of the scroll keys (  or  ). Refer to the chart below to see how the station numbers increment or decrement according to the key press.

Line Direction	Stations:	
	Press 	Press 
<b>N/S</b>	north of zero increments	north of zero decrements
	south of zero decrements	south of zero increments
<b>E/W</b>	east of zero increments	east of zero decrements
	west of zero decrements	west of zero increments
<b>+/-</b>	+ zero increments	+ zero decrements
	- zero decrements	- zero increments

**Notes:** If you select +/— for the line direction, pressing  decreases the station number, possibly to a negative value.

- ▲ + indicates north or east
- ▲ — indicates south or west

The display only shows the — sign, as the + sign is assumed.



## 9. REC→AUTOSTART



*This feature must be disabled to operate the Autograv.*



To disable the **REC→AUTOSTART** feature, do the following:



1. Display the INITIALISE prompt and press the ENTER key.
2. Scroll through the submenus by pressing the  or  key until the following prompt appears:

```
REC->AUTOSTART
CHG? >nnnnn<
```





3. Press the CHANGE key to choose DISABLED.
4. Press the  or  key to scroll to the next submenu.

## 10. SERIAL #

The Autograv serial number should be entered into the memory. The serial number is located on the bottom of the case. Please enter the six right-most digits, as the Autograv will only accept six characters.

To enter the serial number, do the following:



1. Display the INITIALISE prompt and press the ENTER key.
2. Scroll through the submenus by pressing the  or  key until the following prompt appears:

---

## Instrument Parameters

```
SERIAL#      X
CHANGE?
```



3. Press the CHANGE key.

4. Key in the serial number. (Enter the six right-most digits).



5. Press the ENTER key.

## 11. LANG. ENGLISH

Due to memory restrictions, the Autograv only uses English as the operating language.

## 12. HEATER

If the Heater function is selected, then the display heater automatically turns on when the temperature drops below -20°C.





1. Display the INITIALISE prompt and press the ENTER key.

2. Scroll through the submenus by pressing the  or  key until the following prompt appears:

```
HEATER
CHG?  >nnnnn<
```



3. Press the CHANGE key to alternately choose DISABLED or SELECTED.

4. Press the  or  key to scroll to the next submenu.

## 13. TIME HH:MM:SS

You can set both the time and date from this prompt.

To set the time and/or date do the following:



1. Display the INITIALISE prompt and press the ENTER key.
2. Scroll through the submenus by pressing the or key until the following prompt appears:

```
TIME:          XX:XX:XX
CHANGE?       XX:XX:XX
```



3. Press the CHANGE key.

```
TIME:          HH:MM:SS
ENTER?        XX:XX:XX
```



4. Key in the hours and press the ENTER key to go to the next parameter in the time field.



5. Press the ENTER key after you have typed in the seconds.

```
TIME:          HH:MM:SS
CHANGE?       YY:MM:DD
```





6. Key in the year and press the ENTER key to go to the next parameter in the date field.



7. Press the ENTER key after you have typed in the day. When you enter in the day, the clock starts to run.

# LINE SEP

There are no submenus in the **LINE SEPARATION** mode. This mode requires the entry of the regular distance between survey lines in metres or feet.

During a survey, when you change to the next line, the instrument advances its records to the next line number when you press the  LINE and  (or ) keys.

To set the line separation value do the following:



1. Display the **LINE SEP** prompt and press the **CHANGE** key. The following prompt appears:

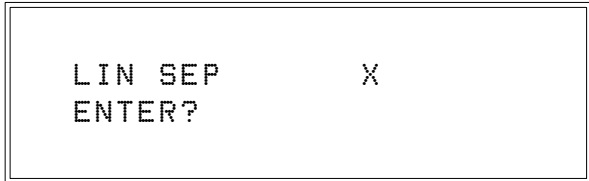

```
LIN SEP      X
ENTER?
```



2. Key in the new line separation value.
3. Press the **ENTER** key.

# STN SEP

There are no submenus in the **STATION SEPARATION** mode. This mode requires the entry of the distance between stations in metres or feet. During the survey, when you change to the next station, the instrument advances its records to the next station number.



If the direction of travel has changed and Automatic Station Incrementation is selected, then the sign (or direction) of the separation parameter has to be changed.

To set the station separation value do the following:



1. Display the STN SEP prompt and press the CHANGE key. The following prompt appears:

```
STN SEP      X
ENTER?
```



2. Key in the new station separation value.
3. Press the ENTER key.

# AUTOGRAV SETUP

There are 14 submenus in the **AUTOGRAV SETUP** mode. Four of the submenus appear only if specific parameters are selected. A second level of submenus is also available for only some of the first level submenus.



1. To enter into the first level submenu of the **AUTOGRAV SETUP**, press the ENTER key and a submenu appears:

Example:

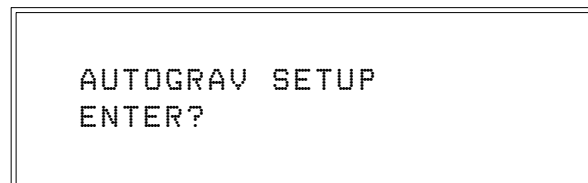

Press:  (ENTER) key

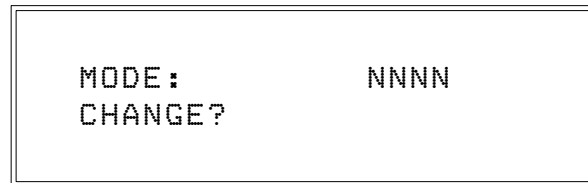



2. To enter into the second level of submenus, follow the prompt that is shown on the second line of the display.



3. To return to the previous level of menu, press the AUX key.

## AUTOGRAV SETUP SUBMENUS

The steps involved to enter a submenu are shown as if you were starting from the **AUTOGRAV SETUP** prompt. However, if you are already in the submenu level, then follow the steps starting from step **2** by pressing the  or  key until the required prompt appears.



## 1. MODE

You can select from three modes of operation:

<b>FLD GRAV</b>	Used for normal field operations
<b>CYCLING</b>	Automatically repeats measurements at a specified cycling time.
<b>NONE</b>	Disables Autograv measurements

To select a mode of operation do the following:



1. Display the AUTOGRAV SETUP prompt and press the ENTER key.
2. Scroll through the submenus by pressing the or key until the following prompt appears:

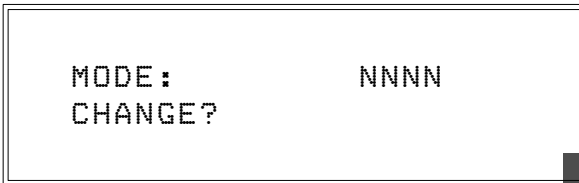

3. Press the CHANGE key.
4. Press the or key until the desired mode appears on the display.



5. Press the ENTER key.

## 2. READ and CYCLE TIME

To set the read time, a numerical value must be entered in seconds, as follows:



1. Display the AUTOGRAV SETUP prompt and press the ENTER key.
2. Scroll through the submenus by pressing the or key until the following prompt appears:

---

## Instrument Parameters

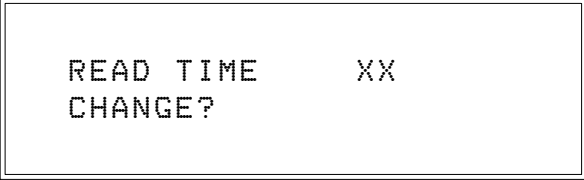

```
READ TIME   XX
CHANGE?
```



3. Press the CHANGE key.

4. Key in a new read time.



5. Press the ENTER key.

If you have selected the **FLD GRAV** or **NONE** mode, then go to step **10** as the **CYCLE TIME** prompt will not appear in the display.

If you have selected the **CYCLING** mode, then:

6. Press the  key and the following prompt appears:

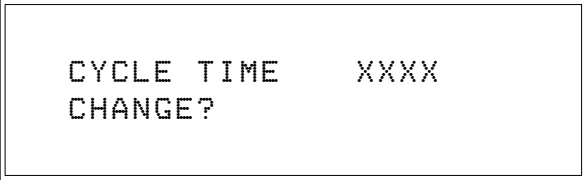

```
CYCLE TIME  XXXX
CHANGE?
```



7. Press the CHANGE key.

8. Key in the new cycling time.

### Notes:

- ▲ For a selected read time, the minimum cycle time is:

$$\text{READ TIME} * (1 + 1/\text{CAL AFTER}) + 5$$

- ▲ To terminate the measurement sequence in the **CYCLING** mode, push the STOP key.
- ▲ To cancel the measurement, press the AUX key. If the Autograv is off (i.e. cycle time is larger than the minimum cycle time), then press the STOP key.
- ▲ If any of the DATA, INFO or SCROLL keys are pressed, then the display will appear to be locked-up. You must then press and hold the ON key for more than 5 seconds to reset the instrument. If any other key is pressed while the meter is in the **OFF** stage of the **CYCLE** mode, then you must press the STOP key to stop cycling.

---

## AUTOGRAV SETUP



9. Press the ENTER key.



10. Press the AUX key to return to the previous submenu.

### a) CHART SEL:



This submenu appears only if you select the **CYCLING** mode. You can choose the full scale range of the output of the digital to analogue converter from the following selections:

- ▲ 0.1 mGal
- ▲ 1.0 mGal
- ▲ 10.0 mGal
- ▲ 100.0 mGal

**Note:** See page 6-3 for details about using the chart recorder.

To set the chart select do the following:





1. Display the AUTOGRAV SETUP prompt and press the ENTER key.
2. Scroll through the submenus by pressing the  or  key until the following prompt appears:

```
CHART SEL:  XX
CHANGE?
```

Parameters



3. Press the CHANGE key.

4. Press the  or  key until the desired chart selection appears on the display.





5. Press the ENTER key.

### 3. STOP: ERR. < LIM

You can set the Autograv to stop a reading (*error limit stop*), if the estimated measurement error value is less than (<) the specified limit. If you select the **ERROR< LIMIT** feature, then the error limit value must be entered in the next submenu. For details on error level, please see page 4-2 and page A-11.

To set the **STOP: ERR< LIM** do the following:



1. Display the **AUTOGRAV SETUP** prompt and press the **ENTER** key.
2. Scroll through the submenus by pressing the  or  key until the following prompt appears:

```
STOP: ERR < LIM
CHG? >NNNNN<
```



3. Press the **CHANGE** key to alternately choose either **DISABLED** or **SELECTED**.
4. If this feature is selected, then press the  key and the following prompt appears:

```
ERR, LIMIT   XXXX
CHANGE?
```



5. To set the error limit value, press the **CHANGE** key.

6. Key in the error limit value.



7. Press the **ENTER** key.

#### 4. CAL. AFTER

You can set the internal calibration frequency with this value. Please refer to page 4-2 for more information about the CAL. AFTER feature.

To set this function do the following:



1. Display the AUTOGRAV SETUP prompt and press the ENTER key.
2. Scroll through the submenus by pressing the or key until the following prompt appears:

```

CAL. AFTER    X
CHANGE?
```



3. Press the CHANGE key.
4. Key in the new calibration after value (seconds). (Refer to page 4-2 for recommended value).



5. Press the ENTER key.

#### 5. CONT. TILT CORR.

You can select or disable this feature. (Please refer to page 4-3 for more information).

To set the tilt correction do the following:



1. Display the AUTOGRAV SETUP prompt and press the ENTER key.
2. Scroll through the submenus by pressing the or key until the following prompt appears:

```

CONT. TILT CORR.
CHG?    >NNNN<
```

---

## Instrument Parameters



3. Press the CHANGE key to alternately choose either DISABLED or SELECTED.
4. Press the or key to scroll to the next submenu.



**Note:** If the *Continuous Tilt Correction* feature is selected in a previous reading, a small square appears on the top line of the display next to GRAV.

## 6. AUTO REJECTION

You can set the Autograv to automatically reject noisy samples (page 4-4) as follows:



1. Display the AUTOGRAV SETUP prompt and press the ENTER key.
2. Scroll through the submenus by pressing the or key until the following prompt appears:

```
AUTO REJECTION
CHG?    >NNNN<
```



3. Press the CHANGE key to alternately choose either DISABLED or SELECTED.
4. Press the or key to scroll to the next submenu.

## 7. TIDE CORRECTION

You can set the tide correction feature using this function as follows:



1. Display the AUTOGRAV SETUP prompt and press the ENTER key.
2. Scroll through the submenus by pressing the or key until the following prompt appears:

## AUTOGRAV SETUP

```
TIDE CORRECTION
CHG?    >NNNN<
```



3. Press the CHANGE key to alternately choose either DISABLED or SELECTED.
4. Press the  key to scroll to the next submenu.



If you select the tide correction feature the following three submenus appear:

- ▲ DEG. LAT
- ▲ DEG. LONG
- ▲ GMT DIFF

### a) DEG. LAT

This submenu appears only if you select the tide correction feature. To set the degrees latitude do the following:



1. Display the AUTOGRAV SETUP prompt and press the ENTER key.
2. Scroll through the submenus by pressing the  or  key until the following prompt appears:

```
DEG. LAT    XX.X
CHANGE?
```



3. Press the CHANGE key.
4. Key in the value (N is positive, S is negative)



5. Press the ENTER key.



---

## Instrument Parameters

### b) DEG. LONG

This submenu appears only if you select the tide correction feature.  
To set the degrees latitude do the following:



1. Display the AUTOGRAV SETUP prompt and press the ENTER key.
2. Scroll through the submenus by pressing the  or  key until the following prompt appears:

```
DEG. LONG    XX.X  
CHANGE?
```



3. Press the CHANGE key.
4. Key in the value (W is positive, E is negative)





5. Press the ENTER key.

### c) GMT. DIFF

This submenu only appears if you select the tide correction feature.  
To set the Greenwich mean time (GMT) difference do the following:



1. Display the AUTOGRAV SETUP prompt and press the ENTER key.
2. Scroll through the submenus by pressing the  or  key until the following prompt appears:

```
GMT. DIFF    X  
CHANGE?
```



3. Press the CHANGE key.



## AUTOGRAV SETUP

4. Key in the value. (GMT - clock time) in hours. This will be negative east of Greenwich and positive west of Greenwich.



5. Press the ENTER key.

## 8. AUTO-RECORD

You can set the instrument so that it automatically records the results of a reading without displaying it on the screen.

To set the Auto-record feature do the following:



1. Display the AUTOGRAV SETUP prompt and press the ENTER key.
2. Scroll through the submenus by pressing the or key until the following prompt appears:

```
AUTO-RECORD  
CHG? >NNNN<
```



3. Press the CHANGE key to alternately choose either DISABLED or SELECTED.
4. Press the or key to scroll to the next submenu.

## 9. GREF.

The GREF value is the gravity offset added to the gravity reading.

To set the GREF value do the following:



1. Display the AUTOGRAV SETUP prompt and press the ENTER key.
2. Scroll through the submenus by pressing the or key until the following prompt appears:

---

## Instrument Parameters



```
GREF:      >  X
CHANGE?
```



3. Press the CHANGE key.

4. Key in the value.





5. Press the ENTER key.

## 10. DRIFT CORRECTION

You can set the Drift correction value based on your calculations (see page 2-43)

### a) Drift

To set the drift correction do the following:

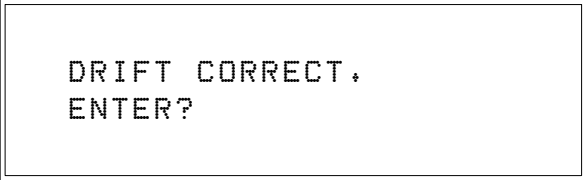

1. Scroll through the submenus by pressing the  or  key until the following prompt appears:



```
DRIFT CORRECT.
ENTER?
```



2. Press the ENTER key.

3. Scroll through the menu using the  or  keys until the following prompt appears:



```
DRIFT:      >  XXX.
CHANGE?
```

---

## AUTOGRAV SETUP



4. Press the CHANGE key.
5. Key in the new drift value.





6. Press the ENTER key.

### b) Change start time



To change the drift correction start time to the current time do the following:



1. Display the AUTOGRAV SETUP prompt and press the ENTER key.
2. Scroll through the submenus by pressing the  or  key until the following prompt appears:

```
DRIFT CORRECT.  
ENTER?
```



3. Press the ENTER key.
4. Press the  or  key until the following prompt appears:

```
CHG, START TIME  
ENTER?
```



5. Press the ENTER key and the prompt shown at the top of the display shows you the current start time.
6. Press the CHANGE key.



The prompt at the top of the display changes to the current real-time clock setting.

---

## Instrument Parameters



### c) Non-current start time

To change the start time to a setting that is not the current time, do the following:

1. Reset the real time clock to a time approximately one minute before the desired start time.
2. Scroll through the submenus by pressing the  or  key until the following prompt appears:

A rectangular box representing the instrument display. The text inside is "DRIFT CORRECT." on the first line and "ENTER?" on the second line, both in a monospaced font.



3. Press the ENTER key.
4. Press the  or  key until the following prompt appears:

A rectangular box representing the instrument display. The text inside is "CHG. START TIME" on the first line and "ENTER?" on the second line, both in a monospaced font.

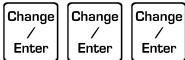

5. Repeatedly press the ENTER key until the prompt shown at the top of the display reaches the desired start time.
6. Reset the real time clock to the current time.



The Warning message INITIALIZE RTC , will appear after an attempt to take a reading when the DRIFT START TIME happens to be ahead of the real time clock (RTC) that has not been initialized yet.

To rectify the problem:

- a. Initialize the RTC
- b. Re-enter the DRIFT START TIME relative to the new RTC.

## 11. INITIAL CONSTANTS

Each instrument has its own individual constants. The five constants for an instrument are provided in the appendix section of the manual. Refer to the *Getting Started* section for an example.

To set your Autograv to its initial constants do the following:



1. Display the AUTOGRAV SETUP prompt and press the ENTER key.
2. Scroll through the submenus by pressing the or key until the following prompt appears:

```
INIT. CONST.:
CHANGE?
```



3. Press the CHANGE key.
4. Set the initial constants to the values shown on the instrument constants sheet. The constants TILT XS and TILT YS require periodic checking (see page 6–12 and page 6–14). If the calibration range is locally available, then the GCAL 1 could be checked (see page 6–18). The constants GCAL 2 and TEMP CO should not be changed.

Use the following example to enter in each constant.

```
GCAL. 1 :      XXX
CHANGE?
```



- a. Press the CHANGE key.
  - b. Key in the GCAL.1 initial constant value.
  - c. Press the ENTER key.
  - d. Press the key to go to the *next* initial constant.
5. Repeat step 4 until you have entered all *five* initial constant values.

Parameters

---

## Instrument Parameters

Aux.  
6

6. Press the AUX key to return to the previous submenu.

# OUTPUT

The measured data is stored in the internal memory and dumped in ascending order according to the:

- ▲ grid
- ▲ line
- ▲ station
- ▲ time values (in this order of priority).



*There is no way to change this order, i.e. the measurement recorded at a station with the lower station number will be dumped before the measurement at the higher station number, regardless of the time it was taken.*

There are seven submenus in the **OUTPUT** mode.

Change  
/  
Enter

1. To enter into the **OUTPUT** mode, press the ENTER key and a submenu appears:

**Example:**

```
OUTPUT
ENTER?
```

Press:  ENTER key

```
AUTOGRAV
START DUMP?
```

Aux.  
6

2. To enter into the second level of submenus, follow the prompt that is shown on the bottom line of the display.
3. To return to the previous level of menu, press the AUX key.

- Notes:**
- ▲ To dump data which is recorded in the **FIELD** Mode, the instrument must be in the **FIELD** Mode - similarly for the **CYCLING** Mode.
  - ▲ For information about interfacing the Autograv, please refer to Appendix C.

## OUTPUT SUBMENUS



The steps involved to enter a submenu is shown from the **OUTPUT** mode. If you are already in the submenu level follow the steps from step 2.

### 1. AUTOGRAV START DUMP

This feature starts the dumping of data that is in memory.

To start the dumping of data do the following:



1. Display the **OUTPUT** prompt and press the **ENTER** key.
2. Scroll through the submenus by pressing the  or  key until the following prompt appears:

```
AUTOGRAV
START DUMP?
```

Parameters



3. Press the **START** key.
  - a. The display shows the prompt **PRINTING**
  - b. When printing is complete, the prompt **FINISHED** appears.
  - c. To pause the printing, press the **STOP** key.
  - d. To resume printing, press the **START** key.
  - e. To stop completely, press the **OFF** key.



---

## Instrument Parameters

### 2. DUMP ALL DATA

For the Autograv, DUMP ALL DATA option performs the same function as the previous AUTOGRAV START DUMP

### 3. PLOT

This submenu enables you to set the characteristics of the plot by setting six of the seven second level submenu parameters. The plotting is simulated by a character position on the print line giving you a simplistic graphic presentation. One line is used per data record.



Two different sets of data can be traced at one time.

The **PLOT** submenu has a further second level submenu for setting the following parameters:

- ▲ TRACE1
- ▲ BIAS1
- ▲ SCALE1
- ▲ TRACE2
- ▲ BIAS2
- ▲ SCALE2
- ▲ START PLOT

To set the plot characteristics, do the following:



1. Display the **OUTPUT** prompt and press the **ENTER** key.
2. Scroll through the submenus by pressing the  or  key until the following prompt appears:

PLOT  
ENTER?



- a) **TRACE1**
3. Press the **ENTER** key and the following prompt appears:





## OUTPUT

```
TRACE1:      >   NNNN
SELECT/ENTER
```

You must select one of the following parameters as your first trace:

```
INFO A      GRAV
INFO B      TILT X
INFO C      TILT Y
INFO D      TEMP
INFO E      SD.G
INFO F      * REJ
INFO G      CAL AFTER
INFO H
```



- a. Press the ENTER key.
- b. Press the  or  key until the desired characteristic appears on the display.
- c. Press the ENTER key again.



Parameters

### b) BIAS1

4. Now press the  key and the following prompt appears:

```
BIAS1:      XXXX
CHANGE?
```

The **BIAS** value is a parameter which establishes a predetermined threshold for the plotting of data. It is useful in that the lower limits of a plot can be eliminated, thus enhancing areas of a plot that are of interest.

## Instrument Parameters

To enter a **BIAS** value:



- a. Press the CHANGE key.
- b. Key in the B I A S 1 value.



- c. Press the ENTER key.

### c) SCALE1

5. Press the  key and the following prompt appears:

```
SCALE1>XXXX< E X
CHANGE?
```



6. If you press the CHANGE key, then the following prompt appears:

```
SCALE1> XXXX < E X
SELECT/ENTER
```



There are *two* sets of parameters (a multiplier and an exponential, i.e. XXXX E<sup>X</sup>) that can change in this prompt:

Multiplier	Exponential Value
XXXX	<E X
There are six multiplier settings:	There are six exponential selections:
+/-1	0
1	1
+/-2	2
2	3
+/-5	4
5	5

---

## OUTPUT



- |   |
|---|
| a. Select the multiplier or exponential value by pressing the  or  key until the desired value appears. |
| b. Press the ENTER key.   |

---

## Instrument Parameters

### d) TRACE2

7. Press the  key and the following prompt appears:

```
TRACE2:      NNNN  
CHANGE?
```

8. You set the second trace characteristics as outlined in “TRACE1” on page 3-32.

### e) BIAS2

9. Press the  key and the following prompt appears:

```
BIAS2:      XXXX  
CHANGE?
```

10. You set the second Bias value as outlined in “BIAS1” on page 3-33.

### f) SCALE2

11. Press the  key and the following prompt appears:

```
SCALE2: XXXX < E X  
CHANGE?
```

12. You set the second scale as outlined in “SCALE1” on page 3-34 in step 6.

**g) START PLOT**

13. Press the  key and the following prompt appears:

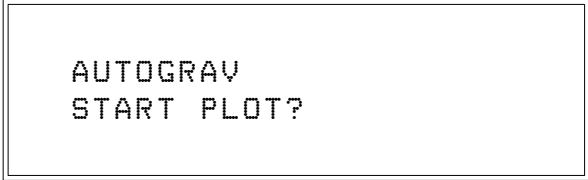

14. Press the START key.



- a. The display shows the prompt PRINTING
- b. When printing is complete, the prompt FINISHED appears.
- c. To pause the printing, press the STOP key.
- d. To resume printing, press the START key.
- e. To stop completely, press the OFF key.



**4. REMOTE**

This function is for SCINTREX engineering use only. Please ignore it.



**5. BAUD RATE**

You must set the baud rate that the instrument sends data. The fastest operating baud rate for the Autograv is 2400 baud. There are five different baud rates in the menu:

- ▲ 2400
- ▲ 1200
- ▲ 600
- ▲ 300
- ▲ 110

To set the baud rate do the following:



1. Display the OUTPUT prompt and press the ENTER key.
2. Scroll through the submenus by pressing the  or  key until the following prompt appears:



---

## Instrument Parameters

```
BAUD RATE:   XXX
CHANGE?
```



3. Press the CHANGE key.

4. Select the baud rate by pressing the  or  key until the desired value appears.



5. Press the ENTER key.

6. If the 2400 baud rate is selected and the printing does *not* start, then you must press and hold the  ON key to clear the apparent hang-up.

## 6. DATA BITS

A choice of 7 or 8 data bits is available.

To set the data bits do the following:





1. Display the OUTPUT prompt and press the ENTER key.

2. Scroll through the submenus by pressing the  or  key until the following prompt appears:

```
DATA BITS:   X
CHANGE?
```



3. Press the CHANGE key.

4. Press the  or  key until the desired value appears.



5. Press the ENTER key.

## 7. CR DELAY



You can set the carriage return (CR) delay according to the printer speed. It is a value between 0 and 999.

**Notes:**

- ▲ A loss of data may require a higher setting
- ▲ The printer supplied by Scintrex requires a CR delay of 0.

To set the carriage return delay do the following:



1. Display the OUTPUT prompt and press the ENTER key.
2. Scroll through the submenus by pressing the  or  key until the following prompt appears:

```
CR DELAY:      X
CHANGE?
```



3. Press the CHANGE key.
4. Key in the carriage delay value
5. Press the ENTER key.



# EDIT

You can do the following three types of changes to the data in memory via the **EDIT** mode:

- ▲ Erase a measurement
- ▲ Change a station, line or grid number, or ancillary information
- ▲ Repeat a measurement for a particular station or line



**Note:** **CYCLING** mode measurements cannot be edited.



**Warning:** Once you enter the **EDIT** mode, filed data can be *permanently* changed or accidentally lost. *Scintrex Limited does not recommend that you use the **EDIT** mode.* It is preferable to edit the data that has been dumped to the computer. For more information contact Scintrex Limited.



# LOCK AUX.

The **LOCK AUX** mode enables you to lock the **AUXILIARY** mode in order to prevent unintentional change of system parameters during surveys.



When the battery is connected or if the CG-3 is reset, the **LOCK AUX** function is automatically *disabled*. All of the system menu options will appear in the display.

## LOCKING THE AUXILIARY MODE

1. Scroll through the main menu by pressing the  or  key until the following prompt appears:

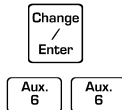
```
LOCK AUX.  
CHG? >DISABLED<
```



2. Press the CHANGE key to choose **SELECTED**
3. Press the AUX. key *twice*. All of the **AUXILIARY** menu options disappear from the display except Station Separation (**\$TN SEP**).
4. If you use the scroll keys  , the following message appears:

```
TO UNLOCK AUX.  
RESET INSTRUMENT
```

## UNLOCKING AUXILIARY MODE

To unlock the **AUXILIARY** mode you must reset the instrument.

---

## Instrument Parameters

To reset the instrument, press and *hold* the  (ON/OFF) key for 5 seconds, while turning on the Autograv.

# FIELD OPERATION

Several features of the Autograv, such as the integrated housing with the built-in shock mounts and the absence of an internal clamping system, make it easy to safely transport the instrument and to obtain accurate readings.

The following pages describe typical field operating procedures for the Autograv.

## PARAMETER SETUP AND KEYPAD OPERATION

The *Getting Started* section describes the basic procedure for taking a reading. The following briefly describes the steps that are involved:

1. Initialize the software with the instrument in the **FIELD** mode.
2. Place the Autograv on the tripod.
3. Push the **START** key once to get into the **ADJUST** mode.
4. Level the instrument via the tripod footscrews.
5. Push the **START** key again to start the reading.
6. Wait until the measurement stops automatically, or press the **STOP** key to terminate it.
7. Push the **RECORD** key to store the data.



---

## Field Operation

The *Firmware* section and Appendix A: *Theory of Operation* give full descriptions of the Autograv software function. This section describes how to select setup parameters and software settings for field operation.

### READING TIME – TERMINATING A READING

A reading can be terminated automatically or manually. How the Autograv automatically terminates a reading depends on the setup of the following options in the AUTOGRAV SETUP.

If you disable the STOP : ERR , < LIM feature, the Autograv terminates the reading when the reading duration (DUR) reaches the preset READ TIME.

If you select the STOP : ERR = , < LIM feature, the Autograv terminates the reading at either ERR < error limit<sup>1</sup> or DUR = READ TIME whichever occurs first. The value of ERR , < LIM is set by the operator.

In either case, you can manually terminate a reading at any time by pressing the STOP key.

The recommended software setting for most applications is *not* to select the STOP : ERR , < LIM feature. For more information on this subject, please refer to page A-12. Instead, select a fixed reading time. The read time DUR = 60 sec will be suitable for most applications. If extra precision is required (microgravity), then the read time could be extended to DUR = 120 sec. Alternatively, you could take two DUR = 60 sec readings and average these during post-processing. In this manner, the repeatability of the readings could be evaluated and possible recovery effects could be revealed.

### CAL. AFTER

As described in Appendix A: *Theory of Operation*, the CAL , AFTER parameter adjusts the ratio of internal calibration samples to gravity samples. Reducing the ratio (reducing the frequency of internal calibration) increases the efficiency of the reading process as more gravity samples are being accumulated in a given time. However, the internal electronic noise increases as the number of ADC calibrations is reduced.

---

1 NOTE: The minimum reading time for readings terminated on the ERR , LIMIT criterion is 15 seconds.



For most applications, a `CAL : AFTER` setting of 12 is recommended.

### LEVELLING REQUIREMENTS AND CONTINUOUS TILT CORRECTION

The Autograv compensates for levelling error by two different methods depending on whether you select or disable the continuous tilt correction feature (`CONT : TILT CORR :`).

**Continuous Correction disabled**—If you disable the `CONT : TILT CORR :` feature, a correction is made based on the last one second samples of tilts X and Y before the reading is terminated. This gives the tilt sensors the maximum time to stabilize before their outputs are used for a correction (refer to Appendix A: *Theory of Operation*). *This setting should be used when the tripod is on a relatively hard surface and the instrument does not move during the reading.* If the instrument is initially levelled to within  $\pm 10$  arcsec about both axes, then rapid readings can be made without stabilization drift in the tilt sensors reducing reading accuracy.

**Continuous Correction selected**—If you select the `CONT : TILT CORR :` feature, a tilt correction is applied to each one second sample based on the tilt sensor outputs at the time the sample is made. *This setting should be used when the tripod is on a soft surface and it is possible that the instrument could move during a reading.* The tilt sensors must be allowed to stabilize for approximately 15 seconds after you level the instrument and before you take a reading. This ensures that accurate corrections are made if the instrument moves. It is also recommended to try to initially level the instrument within  $\pm 10$  arcsec, reducing the size of the corrections which have to be made. This makes it less likely that the instrument tilts beyond the  $\pm 200$  arcsec range of the tilt correction.



**Note:** If the continuous tilt correction feature is selected in a previous reading, then a small square appears on the display in the *previous data* area.

## RECORDING DATA

The way data is recorded depends on whether you select or disable the **AUTO-RECORD** option in the **AUTOGRAV SETUP**.

- ▲ If you disable the **AUTO-RECORD** feature, you must press the **RECORD** key when a reading is terminated.
- ▲ If you select the **AUTO-RECORD** feature, the instrument automatically records the data when the reading is terminated.
- ▲ If you select the **AUTO STN INC** option in the **INITIALISE** menu, the station number is automatically changed by an amount equal to the **STN SEP** entry in the **AUXILIARY** mode menu.
- ▲ If you disable the **AUTO STN INC** option, you can change the station number by a keyboard entry or by using the **SCROLL** keys to change the station setting by an amount equal to the **STN SEP** entry.

## AUTO REJECTION

This feature eliminates noise spikes from a reading and should be selected during field surveys. Samples which are more than 4 standard deviations away from the average are rejected. No rejections are made from the first five samples which are used to build up an average and standard deviation.

While the measurement progresses, the standard deviation is continuously recalculated and the most recent value is used to set the rejection thresholds of  $\pm 4$  standard deviations around the summing gravity average. The standard deviation (SD) of the 1 second gravity signal sample is displayed during calibration measurements, i.e. every 12 seconds, if **CAL AFTER** is set to 12.

Therefore, if you can identify sources of noise spikes, start the reading in a quiet time so that a realistic average and standard deviation can be built up to serve as a basis for rejections. For example, if you want to take a reading beside a road, wait until there are no cars going past before you start the reading.

The auto-rejection feature is also quite useful in the situation where the instrument is cycling and connected through the battery charger to the AC power line. The voltage supplied could be noisy and cause the occasional spikes in readings.

## NOTEBOOK FEATURE

With each measurement that you take, you can enter in up to eight sections of coded information (Info A – Info H). Within each section, up to 5 digits may be entered. To enter in information, do the following:

1. Before a measurement has been recorded, press the INFO key and scroll until Info A appears on the display.

**Note:** Info A is usually used for instrument height.

2. Press the CHANGE/ENTER key and enter in up to 5 digits.
3. Press the CHANGE/ENTER key to complete the entry.
4. To add more information, scroll to Info B etc. and repeat steps 2 to 4. The last section is INFO H.
5. When you have completed all of the necessary information for the specific measurement, press the RECORD key to enter the measurement and the notebook information into memory.

**Note:** Adding information using the INFO key does not have to be in any sequential order.



## TRANSPORTING AND HANDLING

The Autograv case is waterproof and the instrument has been designed to be transported between stations without the dust cover. The dust cover only needs to be installed when the instrument is being shipped or when there is a danger of the front panel or control console being damaged.

To get the best results from your Autograv and to ensure a long working life, treat your instrument carefully:

- ▲ Avoid shocks and jolts caused by hitting the instrument against rocks and trees etc., when taking the instrument out of vehicles and placing it on the tripod.
- ▲ When transporting the instrument in a vehicle, place it on a compliant surface, either a padded seat or a pad made from some other shock absorbing material and fasten it down with a flexible binding material (e.g. seat belt or rubber-based cord).

## OPERATION HINTS



The following are some hints for better instrument results:

- ▲ Whenever the Autograv is not actively being transported between stations by hand, vehicle or aircraft, even for 15 minutes or less, *place it on its tripod and level it*, within the range of the tilt meters, until you are ready to make a measurement. This is especially important if microgravity measurements are being made. Similarly, the Autograv should be levelled on its tripod overnight and whenever it is not on survey (See Appendix B: *Elastic Hysteresis Effects*). If the Autograv has been left *off-level* at rest for some hours or more, it should be set up onto the tripod and left levelled for several hours (e.g. overnight) to stabilize before starting a measurement.
- ▲ When it is necessary to replace the battery during the course of a long day, then take a reading with the original battery, replace the original battery, wait 5 to 10 minutes and then repeat the previous reading to determine if there has been a level shift, however minute.



---

## Operation Hints

- ▲ Ensure that the drift correction and adjustment as described in *Sections 2* (page 2-41) and *6* (page 6-2), the tilt correction adjustments (*Section 6*, page 6-4) and the temperature compensation adjustments (*Sections 2*, page 2-35 and *6*, page 6-1), have been recently updated.
- ▲ Follow the same setup and reading routine at each station. For example, if you are transporting the Autograv by vehicle, take each station reading at approximately the same time interval after the vehicle has stopped.
- ▲ Where it is possible, select station locations which are on solid ground, away from trees, bridges, poles or other potential sources of vibration.

## TRANSPORTATION



- ▲ The CG-3 is an extremely sensitive and precise scientific instrument. It is capable of measuring gravity changes which would result in  $10^{-10}$  metres change in the proof mass vertical position. Note that the hydrogen atom has a diameter of the same size. However, it is inherently robust and well capable of providing accurate relative gravity values under relatively rough (but normal) field handling. In a controlled shock test, one production meter was dropped from various heights to a hard floor. The drops from 40mm, resulting in a 20g peak deceleration at the sensor location, resulted in level shifts of less than 0.01 mGal. The shock isolators and the stops limiting the proof mass movement, reduce the effect of shocks on the sensor. No CG-3/3M sensors have been found to be broken since production started in the second half of 1989. Nevertheless, *it too has limits*, so that careful handling during transportation generally yields better measurement results.
- ▲ To obtain the highest accuracy after unavoidable rough transport, allow the Autograv to settle for a few minutes after being levelled on its tripod, before starting the reading. If rough handling has occurred, there may be a slight, but noticeable drift, for only a few minutes immediately after levelling.
- ▲ Whereas the Autograv may be placed in any orientation (tilted or on its side) without damage, it is preferable to keep it upright in storage or during shipment. When at rest it should be kept levelled (see above) for best results. If for some unavoidable reason, these precautions have not been followed, then allow time for the CG-3 readings to stabilize at

---

## Field Operation

the first station. By observing the sequential readings (e.g. 60 or 120 seconds averaging) you can tell if the unit is stable by judging their convergence.

## MOTION NOISE

Motion of the base of support of the meter may induce noise and consequent reading errors. Such motion may be caused by:

**Poor ground conditions**—Soft ground, tree root movement and settling of the tripod. These are improved by the *Tilt Correction* (continuous or not) which is described on page 4-3.

**Microseismic noise** —This is due to motion of the continental crust as an effective wave guide for seismic surface waves of (usually) a 5 to 7 second period. These effects may be caused by long-period ocean waves striking coast lines. They are most severe in islands in the seas (e.g. Ireland), but may at times be troublesome even in the centre of large continents.

The effect of microseismic noise may best be reduced by measuring for larger periods and thus achieving the required statistical accuracy of the measurement.

**Earthquake shock waves**—The shock waves from an earthquake may affect measurements so much that they cannot be carried on while these shock waves last.

**Industrial traffic noise** —Vibration due to industrial activity and/or the nearby movement of heavy vehicles generally introduces higher frequency seismic noise (e.g. 4 to 100 Hz). Gravity stations which are near such sources of noise should be avoided. Where they cannot be moved to a quieter location, measure longer, e.g. 120 sec instead of 60 sec.

The standard deviation of 1 second measurement samples is a good indication of the seismic noise, especially longer period microseismic noise. During quiet periods, SD is in the range of 0.010 to 0.030 mGal, whereas, during storms on open seas, it could increase to 0.150 mGal (measured in Toronto) or even higher near the sea coast. It could go to 0.5 mGal and higher during remote but strong earthquakes. The shorter period industrial noise

is reduced by signal averaging over 1 second so that the 1 second samples are less responsive to this noise. Noise spikes are removed by auto rejection of 1 second samples.

## WIND

Wind striking a gravity meter can cause both vibration noise and reduction in gravity by tilting the meter out of verticality. Tilting the meter so that it is not vertical tends to reduce the apparent gravity value, despite the statistical averaging of the gravity measurements and the automatic tilt correction.

A windbreak should be devised to protect the meter from the effect of wind. A simple windbreak can be made from a sheet of canvas about 1.5m square, fastened on each of two opposing sides to two aluminum tubes or wooden rods (each, about 2m (6.5ft) long). The operator (or a helper) then holds the rods outstretched and vertical on the upwind side of the gravity meter to shield it from the wind. Alternatively, a large (golf) umbrella could also be used.

## BASE STATION SELECTION

By repeated gravity measurement at the base station, the residual drift could be determined.

In any survey area, try to select base stations which:

- ▲ are easily accessible to the other stations to be surveyed, e.g. perhaps near the centre of the survey area
- ▲ have low vibration noise, e.g. away from industrial, vehicular or natural vibration sources (rivers, beaches, volcanoes etc.) and
- ▲ have a hard, level surface where the precise tripod location may be repeated, and the level of the gravity meter maintained.

## COLD WEATHER OPERATION

In extremely cold weather (e.g. well below 0°C) the battery life will be reduced because of:

- ▲ increased battery drain required to maintain the temperature of the sensor and to heat the display.
- ▲ reduced capacity of the battery because the battery becomes cold.

An external battery belt and extender cable (optional) can reduce the effect of a cold battery as the external battery is kept warm by the heat of the operator (see page 5-2).



**Tip:** If desired, the external battery may be disconnected before measurement only so that there will be no interconnecting cable during the measurement time.

## USING THE CG-3 BEFORE WARM-UP STABILIZATION IS COMPLETE

After the CG-3 has been powered down for more than 2 days, it is recommended that the unit go through a warm-up period of 48 hours (see also page 2-35), followed by the drift correction procedure which takes another 12 hours (see also page 2-41). In some situations, it may not be possible to wait this long before a survey is started.

After a 12-hour period, the instrument operates properly, *except* that the long-term drift will not be stable. Good results can usually be obtained after this 12-hour period, if you follow these steps:

---

## Dumping Data

1. After the instrument has been powered up for 12 hours, check the Temperature compensation and adjust if necessary (see page 2-35). Note that the instrument does not have to be connected to the charger to warm up. It can be warmed up by simply plugging in the battery. However, due to the high initial load, the battery will discharge more quickly than normal.
2. Design the field survey such that there are frequent repeat readings at base station(s) and correct for the drift in the data reduction. *Do not attempt to adjust the DRIFT constant in the CG-3 software yet.* For the first day of surveying, it is advisable to re-occupy base stations approximately once every two hours. On the second day, once every 4 hours is probably sufficient.
3. At the end of the first and second days work, check the Temperature Compensation and adjust if necessary.
4. At the end of the second days work, adjust the Drift Correction (see page 2-41). After this, the instrument can be operated normally.

# DUMPING DATA

Once the Autograv has been physically linked to a computer by means of adapters and serial cables, it is necessary to make them communicate. The interface software may be a commercially available communications package, or may be custom software dedicated to the user's hardware configuration.

Commercial communications packages tend to be quite comprehensive and for the simple function of transferring data to a computer from the Autograv are unnecessarily complicated.

Scintrex provides for the Autograv users communication software called **IDUMP**. This program is the property of Geosoft and is provided free of charge. Please observe all Geosoft requirements in the use and distribution of this software as stated in the copyright message. It supports serial port COM1/COM2 and a baud rate of up to 2400 BPS (for Autograv). It is self-documented and easy to use. Should you have any questions or concerns, please contact Scintrex Ltd.

---

## Field Operation

## BATTERY AND CHARGER

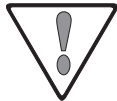

### **Attention:**

**The instrument must be powered at all times (even during storage)!**

## LOSS OF POWER

The instrument must be powered at all times (even during storage) by either the internal 12V battery or the battery charger. If a loss of power to the instrument occurs, then several things happen:

- ▲ After a few seconds of power loss, the clock setting is erased and must be reset to the current time after power is resumed.
- ▲ The thermostat loses power and the instrument begins to cool down. The consequences of the power loss depends upon the length of time that the instrument is powered down.

Check the temperature output in the **ADJUST** mode to see when the thermostat is stable. The stabilization time increases as the powered-down time increases.

---

## Battery and Charger

Power Off Time	Stabilization Time Required After Power Up
a few minutes	30 minutes (approx.)
12 hours	24 hours (approx.)
48 hours or more	48 hours (approx.)



- ▲ If the instrument is powered down for more than 48 hours, the contents of the memory, *including* the Autograv initialization constants could be lost. If this occurs, you will have to go through the Initialization procedures outlined in the *Getting Started* section.

## BATTERY

The standard internal rechargeable battery for the Autograv is the Panasonic 12V/7.2Ah (previously, the Sonnenschein 12V/6Ah battery was used). When this battery is fully charged, it provides enough power to operate the instrument throughout a normal survey day. However, battery life-time increases as the ambient temperature increases. At 25°C, the newly installed battery lasts for 15 to 16 hours but at -10°C, the battery lasts for only seven hours.

## TEMPERATURE EFFECTS

A typical plot of CG-3 service hours against the ambient temperature for the Panasonic battery is shown in Figure 12 on page 5-3. At low temperatures, the service hours decrease rapidly for two reasons:

- ▲ low temperatures reduce the inherent electrochemical capacity of the battery.
- ▲ the load on the battery increases as the temperature drops, in order to maintain the CG-3 sensor at its constant operating temperature.

To circumvent the first effect and extend the battery life under cold weather conditions, an external battery belt (optional) can be provided. This battery belt is strapped to the operator's waist underneath the clothing and thereby kept warm. An extender cable to the charger plug on the Autograv provides



power to the instrument. Once the external battery supply has been connected, the internal battery, if discharged, should be removed, as it should not be kept in place for very long thereafter. When the internal battery has been replaced, the external battery may be then disconnected without any interruptions of the temperature stabilization of the sensor.

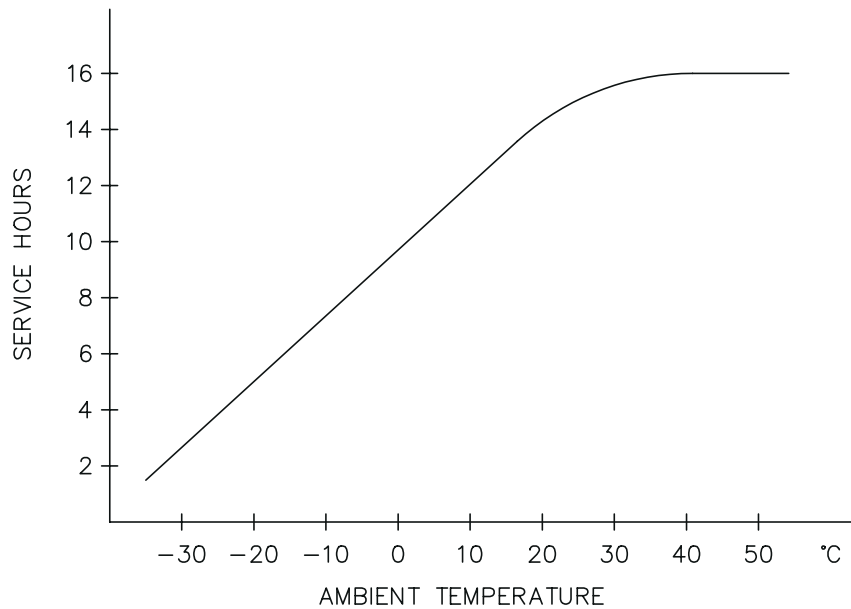

**Figure 12** Typical CG-3 Service Hours vs. Temperature (Panasonic LCR 6V 7.2P)

## VOLTAGE



**Low battery warning**—If the battery voltage drops below 10.5 volts, the Autograv emits an audible low battery level alarm. *The battery has approximately 1 hour left of operating time after the alarm sounds.* The battery should then either be recharged by connecting the instrument to the charger or replaced with a charged battery.

**Checking battery voltage**—You can check the battery voltage at any time by pressing the INFO key on the keypad and scrolling to BATT XXX. You must *divide* the value shown on the display by a factor of 10 to obtain the actual battery voltage. For example, a value of 1 1 7 indicates that the voltage supply is close to 11.7 volts.

---

## Battery and Charger

**Note:** The battery voltage display is not automatically updated. To update, you must press the INFO key again.

If you press the INFO key quickly several times, you will notice a variation in the displayed battery voltage. This is due to the thermostat heater switching on and off. When the battery is fully charged, the maximum value that is displayed is 13.8 which is 13.8 volts. The minimum value that is displayed is 10.5 which is 10.5 volts.

## LIFE EXPECTANCY

The life expectancy of the battery is approximately 200 cycles (each cycle being a complete discharge and recharge). In standby operation, the life expectancy is 4 to 5 years. Two batteries are supplied with each Autograv.

If the CG-3 battery has been in use in the field for 150 to 200 days, then its capacity to hold a charge may be significantly less than it was new. At this point, it is more economical to replace the battery with a new one, rather than suffer with the operational inconvenience of a reduced battery life and frequent battery changes in the field. Figure 13 on page 5-4 illustrates the typical deterioration of the battery capacity with the number of discharge/charge cycles.

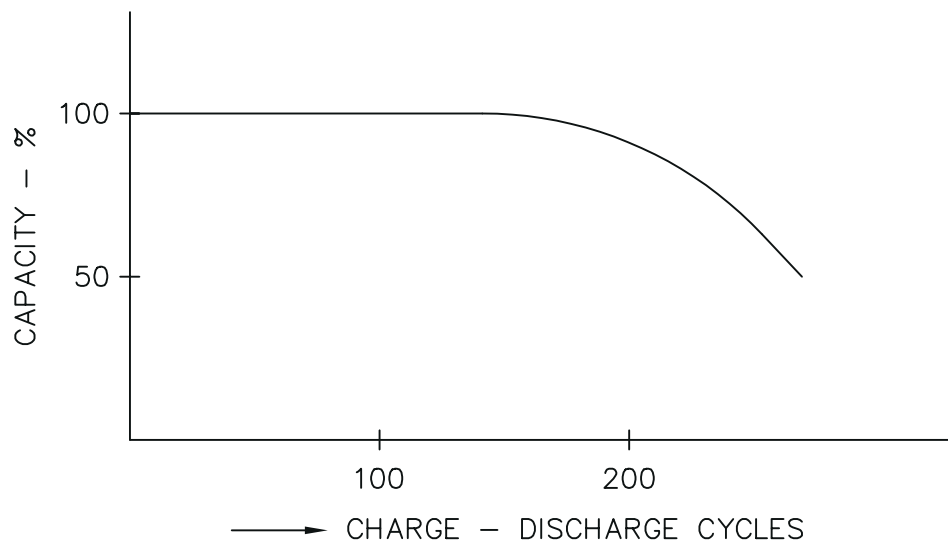

**Figure 13** Typical battery capacity vs. Charge-Discharge cycles

## REPLACING

You should replace both of your batteries with new ones, approximately once a year if your CG-3 has been in relatively steady use. You should replace an individual battery even earlier, if you should find that its capacity has been reduced, even after it has been fully charged.

When replacing a CG-3 battery, it is recommended that you do so only with one of a type which has been tested and approved by Scintrex. To date, the only recommended batteries are:

- ▲ Panasonic LCR6V/7.2P, 12V/7.2Ah
- ▲ Sonnenschein Dryfit A200 12V/6Ah (used in the CG-3S prior to 1994). Please note that this battery is now being manufactured by Mallory/Duracell, but still uses the same designation (Dryfit A-200 12V-Ah)

The reason why a general approval cannot be given for all 12V lead-acid batteries is that each brand may have different charging requirements, resulting in incompatibility with the CG-3 charger.

### Hints:

1. Do not operate charger at temperatures below -25°C.
2. Do not store discharged batteries in cold temperatures.
3. Replace a battery after about 200 days of field use, as it will no longer provide a proper *lifetime* in the field.

## CHARGER

The charger serves three functions:

- a. Powering up the Autograv via an AC outlet
- b. Charging the internal rechargeable 12V battery
- c. Charging spare batteries via the two external output connectors

When the charger is connected to the Autograv it provides current to charge the internal battery and to maintain its charge. It also enables the internal battery to be removed without affecting the performance of the instrument.

---

## Battery and Charger

Batteries are charged by applying a constant voltage. The charging current is self limiting. The required charging voltage varies with temperature. To accommodate this the Autograv charger has a temperature sensor in the end of the output cable which is used to automatically adjust the charging voltage to the correct value.

When the Autograv is connected to the charger, the battery in the instrument (if connected inside the battery compartment) is automatically charged. Up to two spare batteries can be recharged by plugging them into the sockets on the side of the charger.

## CHARGING TIME

Charging time for batteries is approximately eight hours. For best charge acceptance by the batteries, the ambient temperature should be in the 20° to 30°C range, wherever possible.

## CHARGER LINE VOLTAGE

The charger can be used with either of these line voltages:

- ▲ 115V
- ▲ 230V

When you are selecting a line voltage you must set the charger voltage switch to the correct line voltage.

### Selecting an alternate voltage

1. Ensure that the charger is unplugged from the AC outlet.
2. Using a small flathead screwdriver, flip the recessed voltage switch that is on the front of the charger to the appropriate setting.

- Change the charger fuse to the appropriate rating as shown below.

Voltage	Fuse
115V	0.75A
230V	0.375A

When you plug the charger into an AC outlet, the green light turns on to indicate that the charger is working.

### Notes:

- ▲ To operate the Autograv with the 230V setting, you need the optional 230V adaptor plug.
- ▲ If you use the 0.75A fuse with the 230V setting, then the battery and the charger will not be protected against potentially dangerous fluctuations in the line voltage, or the electronic component failure.
- ▲ If you use the 0.375A fuse with the 115V setting, then you will blow the fuse when you plug the charger into an AC outlet.
- ▲ The battery charger gets hot when in use. This is normal and the charger has an automatic thermal limiting circuit to reduce power dissipation before overheating occurs. To reduce heating, ensure that the charger is uncovered in an open place and that air flow over the case and fins is not restricted.
- ▲ If the Autograv is plugged into the charger for an extended period of time, then remove the battery compartment door.
- ▲ If the instrument has a discharged battery in it when the charger is connected, then wait for 1 to 2 hours before plugging in another discharged battery into a side socket.
- ▲ If the ambient temperature is *below* -25°C, then do not charge a battery using the charger.



**Warning:** Do not connect the Autograv to any external 12V DC-supply other than a spare Autograv battery or the authorized charger supplied by Scintrex. For example, do not power the Autograv from the electrical system of a vehicle, the voltage from such sources may readily exceed the permissible input voltage to the Autograv and *cause serious damage* to its electronic system, thus voiding the warranty.

## BATTERY COMPARTMENT FUSE

There is a 3A fuse located inside of the battery compartment. This fuse protects the instrument from dangerous voltages.

**Note:** If this fuse is blown, then the Autograv will not operate.

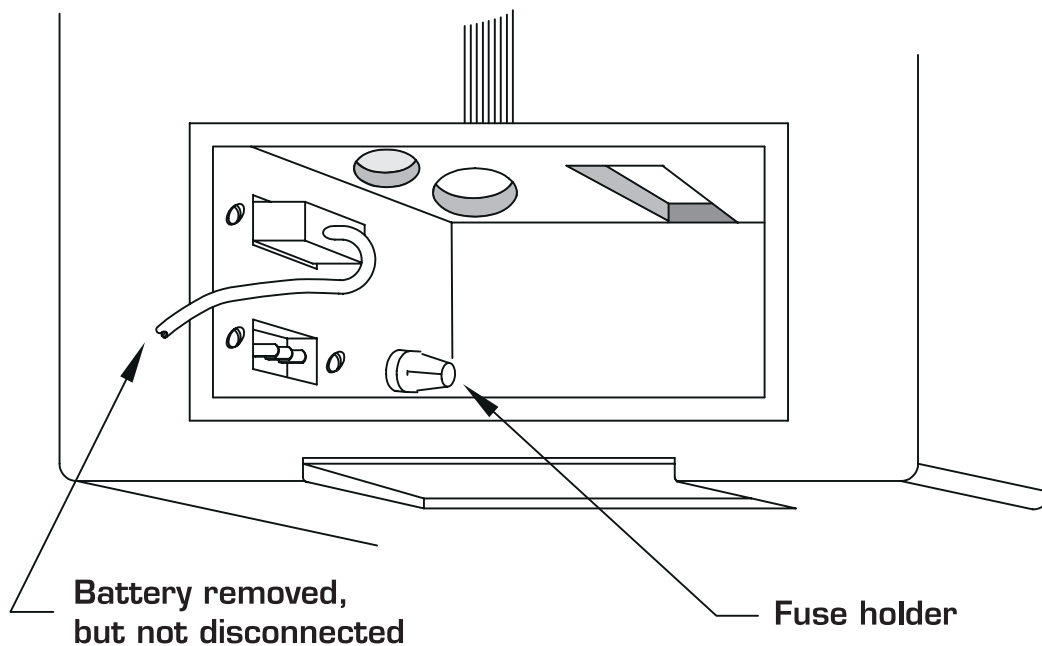

Figure 14 Inside of Battery Compartment

## HOW TO CHANGE A BATTERY

1. Open the battery compartment door by pressing down on the two latches and lifting the cover away from the instrument (see Figure 15 on page 5-9).
2. Without unplugging the discharged battery, remove the battery from the battery compartment by pushing on the left side of the battery and then pulling the *black tab* towards you so the battery can slide out (see Figure 15 on page 5-9).

---

## How to Change a Battery

3. Insert the connector of the new battery into the spare socket on the left hand side of the battery compartment wall (see Figure 15).
4. Unplug the discharged battery.
5. Before you reinstall the new battery, place your hand inside and flatten the *black tab* against the bottom, side and top of the compartment. If the *black tab* is not pressed against the walls of the compartment, then the battery will not fit and the foam padding will be damaged.
6. Reinstall the battery compartment cover.

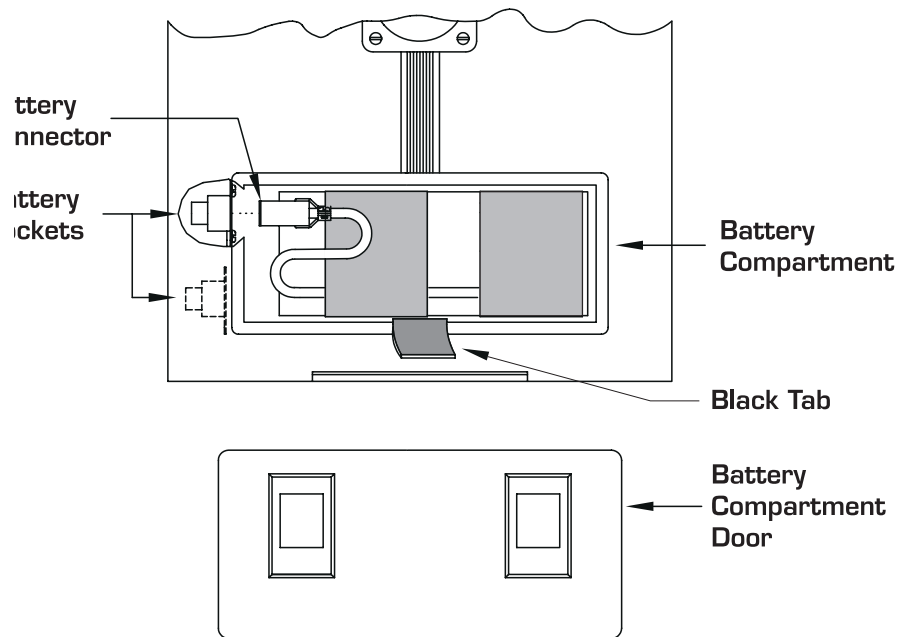

**Figure 15** Battery installation

---

## Battery and Charger



# MAINTENANCE

There are several instrument parameters that you need to periodically check and adjust, if required. You can adjust some of these parameters by using the keypad while other parameters must be physically adjusted via the sensor front panel. As the instrument gets older you will not have to check these parameters as often.

The parameters that require periodic checks and adjustments are:

- ▲ Temperature compensation
- ▲ Drift correction
- ▲ Tilt correction
- ▲ Calibration constant

## TEMPERATURE COMPENSATION



**Important:** The temperature compensation must be checked and adjusted (if required) before the drift correction.

The reason for apparent long term drift of the monitored chamber temperature is the slow aging of thermistors. The thermistors are used for the sensor chamber thermal stabilization and the chamber temperature monitoring and compensation. The measurement range of the temperature monitoring circuits is  $\pm 3$  mK. It is advisable to readjust the reading offsets well before the ends of the range are reached.

Check the temperature compensation if the instrument has been turned off for more than two hours and also periodically during field operations.

---

## Maintenance

With the instrument at room temperature, the temperature reading must be within the range of:  $-1.0 \text{ mK} < \text{TEMP} < +1.0 \text{ mK}$

Please refer to the *Getting Started* section on how to check and adjust the temperature compensation (starting on page 2-35). Also, note that the adjustment does not change the sensor chamber temperature, but only the temperature reading offset circuits. Consequently, the gravity readings will differ by the value  $\Delta\text{TEMP} \times \text{TEMPCO}$ , where  $\Delta\text{TEMP}$  is the temperature reading change and the  $\text{TEMPCO}$  is the software correction constant (see page A-15). The previous level would be re-established by using the  $\text{GREF}$  function, see page 3-25.

## DRIFT CORRECTION

1. During the first month of operation for a new instrument, check the drift correction once a week.
2. After this four week period, check the drift correction once every month or longer depending on the individual characteristics of the instrument.



**Important:** If an instrument has been turned off for several weeks or more (which should *never* be done without a valid reason), then the setup procedure outlined in Section 2 must be followed as if the instrument was new.

3. In any event, the drift correction must be checked at intervals of no more than three months apart and the drift value and start time updated accordingly (see page 3-26 to page 3-29).

## OBTAINING ACCURATE DRIFT CORRECTION RESULTS

- ▲ Reset the drift correction start time (refer to page 2-41) at the same time as the new drift constant is entered. The drift correction start time must be reset before the difference between it and the current time exceeds 4 months. (Refer to equation 9.8 on page A-13 in Appendix A)
- ▲ The drift correction should *not* be adjusted on the basis of repeat measurements at base stations during a field survey, but rather with drift measurements obtained from a stationary instrument. The drift correc-

tion feature corrects for relatively constant long term instrument drift due to stress relaxation in the elastic system. There may be a small amount of additional drift induced by transportation and handling. The drift correction is not intended to eliminate drift due to transportation as it is generally not constant and depends on the conditions of transportation. This residual drift can be determined by repeated measurements at selected base stations.

- ▲ Ensure that the tide correction is selected and properly adjusted while measuring the drift correction.
- ▲ To obtain the most accurate estimate of instrument drift, connect a chart recorder to the instrument during the measurement period. This enables you to visually filter out any noise from the chart data. The drift is then calculated from the slope of a straight line drawn through the noise free data. The most convenient chart speed for this measurement is 0.5 or 1cm/hr, with a sensitivity of 1mGal full scale.

### Using a Chart Recorder

When the instrument is in **CYCLING** mode, you can obtain an analog output of the reading by connecting the optional chart recorder cable (P/N 780-542) to the instrument front panel. The analog signal is always in the range of 0-1V with the scale being selected in the software through the **CHART SELECT** submenu of the **AUTOGRAV SETUP**. The preset ranges available to you are: 0.1, 1, 10 and 100 mGal full scale.



**Hint:** The *most useful* chart scale selection for drift measurement is 1mGal full scale.

Before connecting the chart recorder cable to the recorder, check that it is switched to 1V full scale deflection and that it is correctly calibrated and zeroed. Chart speed depends on the cycle time and the application.

## TILT CORRECTION ADJUSTMENT

The perfect tilt adjustment condition is the coincidence of instrument zero tilts as defined by the digital readout of the level bubbles and tilts referred to the horizontal as defined by the maximum sensor output.

To achieve these conditions, you can adjust the tilt sensor zero position and the tilt sensor sensitivity. The sensor zero setting is a hardware adjustment while the tilt sensor sensitivity is adjusted via the keypad.

The tilt sensors are adjusted before the instrument leaves Scintrex Ltd., and since the tilt sensors are very stable under normal operating conditions they only need to be checked approximately every two months.

### TILT SENSOR ZERO ADJUSTMENTS



The zero errors  $X_E$  and  $Y_E$  are measured and adjusted one axis at a time starting with the X-axis.

These should be checked approximately once every two months.

#### Measuring $X_E$

1. Initialize the system by setting the following parameters.

Parameter	Setting
MODE	FIELD
READ TIME	120
TILT CORRECTION	SELECTED
TIDE CORRECTION	SELECTED
AUTO REJECTION	SELECTED
STOP: ERR. < LIM	DISABLED

---

## Tilt Correction Adjustment

2. Place the Autograv on the tripod in a quiet location with a solid floor (concrete is preferable). A wooden floor or carpet is *not suitable*.
3. Press the START key. The TILT value appears on the display.
4. Adjust the tripod until  $X = 150 \pm 10$  and  $Y = 0 \pm 5$ .
5. Wait for 5 minutes and then note the exact value (**X1**) as shown on the display.
6. Take a reading and record the reading as **R1**.
7. Rotate the front footscrew *counter-clockwise* until  $X = -150 \pm 10$  and if necessary adjust the rear footscrews so that  $Y = 0 \pm 5$ .
8. Wait for 5 minutes and then note the exact X value (**X2**) as shown on the display.
9. Take a reading and record the reading as **R2**.
10. Calculate the *zero error* by using the following formula.

$$X_E = \frac{R2 - R1}{X1 - X2} \times 43386$$

where **X1**, **X2** and **X<sub>E</sub>** are in units of *arc sec* and **R1**, **R2** are in mGal.

Example:

$$\begin{array}{ll} X1 = +156 & R1 = 4236.58 \\ X2 = -149 & R2 = 4236.54 \end{array}$$

$$X_E = \frac{4236.54 - 4236.58}{156 - (-149)} \times 43386$$

$$X_E = \frac{-0.04 \times 43386}{305}$$

$$X_E = -5.7 \text{ arc sec}$$

## Fine Adjustment of $X_E$

If  $X_E \neq 0$ , the Autograv must be adjusted so that the non-level readings are correctly compensated.

1. Leave the instrument in the  $X = X_2, Y = 0$  orientation.
2. Remove the Autograv faceplate by unscrewing the four 4-40 oval screws. Refer to the page 2-36.
3. Press the START key to put the instrument in the **ADJUST** mode.
4. Check the TILTS value and if necessary set  $Y = 0 \pm 2$  and  $X = X_2 = -150 \pm 10$ .

You do not have to adjust  $X_2$  to the previous value.

5. Adjust the *X Tilt Sensor Fine Adjustment* potentiometer (see Figure 16 on page 6-7) while you view the TILTS  $X$ -value on the liquid crystal display until  $X_2' = X_2 + X_E$



**Note:** Potentiometer sensitivity is approximately 2.5 arcsec /turn and adjusting the pot. *counter-clockwise increases* the reading.

**Example:**

$$X_2' = -149 + (-5.7)$$

$$X_2' = -149 - 6$$

$$X_2' = -155$$

**Note:** If the *Fine Adjustment* potentiometer runs out of range in step 5, refer to the section on the *Tilt Sensor Coarse Zero Adjustment* starting on page 6-10.

6. Repeat the measurement of  $X_E$  and make another adjustment if necessary.

## Tilt Correction Adjustment

Maintenance

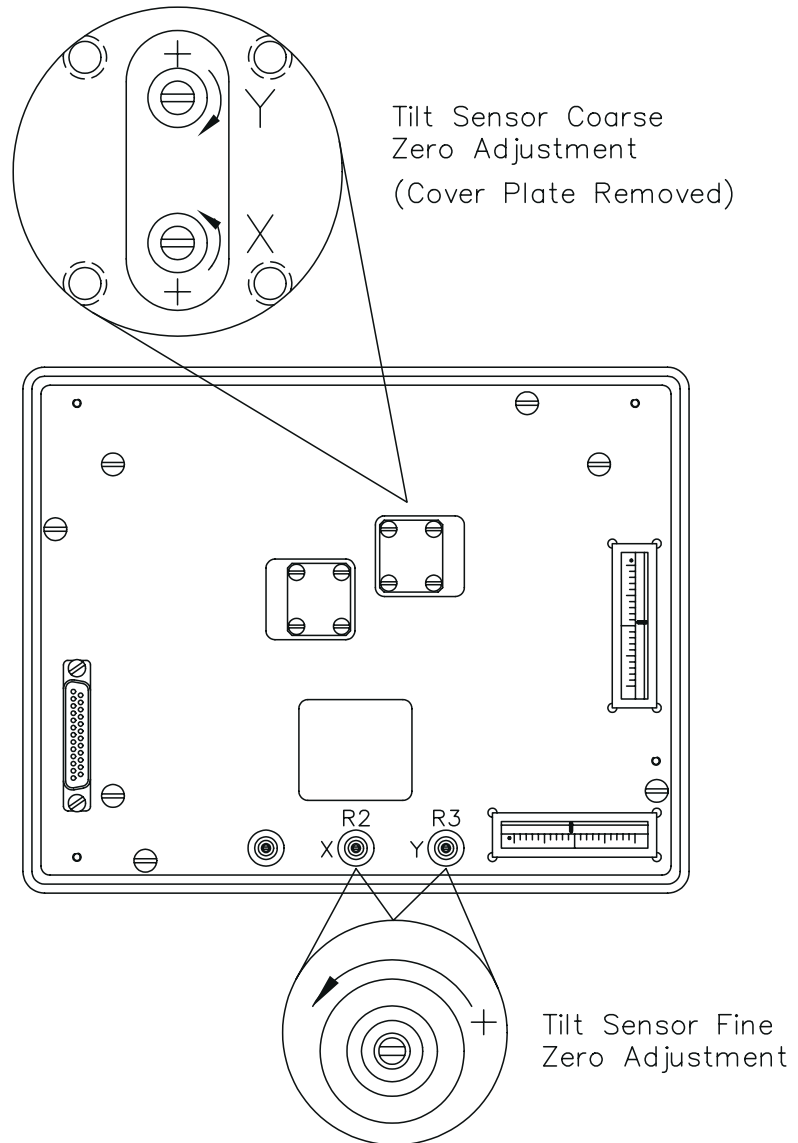

**Figure 16** Autograv Faceplate Removed with R2, R3 and Tilt Sensor Coarse Zero Adjustment Shown

---

## Maintenance

### Measuring $Y_E$

The following procedure is basically the same as that for measuring  $X_E$ .

1. Press the **START** key in order to display the **TILT5** value.
2. Rotate the rear footscrews until  $Y = 150 \pm 10$  and if necessary, adjust the front footscrews until  $X = 0 \pm 5$ .
3. Wait for 5 minutes and then note the exact  $Y$  value (**Y1**) as shown on the display.
4. Take a reading, and record the reading as **R1**.
5. Adjust the rear footscrews until  $Y = -150 \pm 10$  and if necessary, adjust the front footscrew until  $X = 0 \pm 5$ .
6. Wait for 5 minutes and then note the exact  $Y$  value (**Y2**) as shown on the display.
7. Take a reading, and record the reading as **R2**.
8. Calculate the *zero error* by using the following formula.

$$Y_E = \frac{R2 - R1}{X1 - X2} \times 43386$$

where **Y1**, **Y2** and  $Y_E$  are in units of *arc sec* and **R1**, **R2** are in mGal.

**Example:**

$$\begin{aligned} Y1 &= +156 \\ Y2 &= -149 \end{aligned}$$

$$\begin{aligned} R1 &= 4236.58 \\ R2 &= 4236.54 \end{aligned}$$

$$Y_E = \frac{4236.54 - 4236.58}{156 - (-149)} \times 43386$$

$$Y_E = \frac{-0.04 \times 43386}{305}$$

$$Y_E = -5.7 \text{ arc sec}$$



## Fine Adjustment of $Y_E$

If  $Y_E \neq 0$ , the Autograv must be adjusted so that the non-level readings are correctly compensated.

1. Leave the instrument in the  $Y = Y_2, X = 0$  orientation.
2. Remove the Autograv faceplate by unscrewing the four 4-40 oval screws. Refer to page 2-36.
3. Press the **START** key to put the instrument in the adjust mode.
4. Check the **TILTS** value and if necessary set  $Y = Y_2 = -150 \pm 10$  and  $X = 0 \pm 5$ .

You do not have to adjust  $Y_2$  to the previous value.

5. Adjust the *Y Tilt Sensor Fine Adjustment* potentiometer (see Figure 16 on page 6-7) while you view the **TILTS Y** value on the liquid crystal display until

$$Y_2' = Y_2 + Y_E$$

**Note:** Potentiometer sensitivity is approximately 2.5 arc sec/turn and adjusting the pot. *counter-clockwise increases* the reading.



**Example:**

$$Y_2' = -149 + (-5.7)$$

$$Y_2' = -149 - 6$$

$$Y_2' = -155$$

**Note:** If the Fine Adjustment potentiometer runs out of range in step 5, refer to the section on the *Tilt Sensor Coarse Zero Adjustment* starting on page 6-10.

6. Repeat the measurement of  $Y_E$  and make another adjustment if necessary.

## TILT SENSOR COARSE ZERO ADJUSTMENT

This adjustment is performed if the fine adjustment potentiometer runs out of range during the *Fine Zero Adjustment*.

### Coarse Adjustment of $X_E$

1. Remove the *Coarse Zero Adjust* cover.
2. Underneath the cover is an O-ring seal. This ensures that no moisture or dust can enter into the adjustment pot. Remove the O-ring seal and place it in a dry clean place.
3. Place the Autograv into the **ADJUST** mode.
4. Level the Autograv until  $X = 0 \pm 2$  and  $Y = 0 \pm 10$ .



**Important:** Do not readjust the leveling of the instrument during the proceeding steps.

5. Centre the *Fine Zero Adjustment* by rotating the potentiometer *clockwise* for 25 turns followed by 10 turns *counter-clockwise*.
6. Carefully rotate the X tilt sensor coarse zero adjustment until  $X = X_E$ .



**Note:** Potentiometer sensitivity is 2000 arc seconds/turn and adjusting the pot. *counter-clockwise increases* the reading. Carefully rotate the screw using very small increments while viewing the liquid crystal display.

7. Wait 10 minutes for the Autograv to stabilize and readjust if necessary.
8. Repeat the *Fine Adjustment* procedure on page 6-6.

## Coarse Adjustment of $Y_E$

1. Remove the *Coarse Zero Adjust* cover.
2. Underneath the cover is an O-ring seal. This ensures that no moisture or dust can enter into the adjustment pot. Remove the O-ring seal and place it in a dry clean place.
3. Place the Autograv into the **ADJUST** mode.



**Note:** If the instrument turns off during the adjustment, then press the ON key.

4. Level the Autograv until  $Y = 0 \pm 2$  and  $X = 0 \pm 10$ .

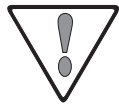

**Important:** Do *not* readjust the leveling of the instrument during the proceeding steps.

5. Centre the *Fine Zero Adjustment* by rotating the potentiometer *clockwise* for 25 turns followed by 10 turns *counter-clockwise*.
6. Carefully rotate the Y tilt sensor coarse zero adjustment until  $Y = Y_E$ .



**Note:** Potentiometer sensitivity is 2000 arc seconds/turn and adjusting the pot. *counter-clockwise increases* the reading. Carefully rotate the screw using very small increments while viewing the liquid crystal display.

7. Wait 10 minutes for the Autograv to stabilize and readjust if necessary.
8. Repeat the *Fine Adjustment* procedure on page 6-9.

## TILT SENSOR SENSITIVITY ADJUSTMENT (TILTXS, TILTY S)

This adjustment is performed after both the tilt sensor zero adjustments are performed. In general, the tilt sensor sensitivity is more stable than the zero point, so it only needs to be checked once every four months.

### Measuring X-axis Sensitivity

1. Initialize the firmware by setting the following parameters.

Parameter	Setting
MODE	FIELD
READ TIME	120
TILT CORRECTION	SELECTED
TIDE CORRECTION	SELECTED
AUTO REJECTION	SELECTED
STOP: ERR. < LIM	DISABLED

2. Place the Autograv on the tripod in a quiet location with a solid floor (concrete is preferable). A wooden floor or carpet is *not suitable*.
3. Press the START key. The TILT S value appears on the display.
4. Level the instrument until  $X = 0 \pm 10$  and  $Y = 0 \pm 10$ .
5. Take a reading and record it as **R0**.
6. Adjust the tripod until  $X = 0 \pm 150$  and  $Y = 0 \pm 5$ .
7. Wait for 5 minutes and then note the exact value (**X1**) as shown on the display.
8. Take a reading and record the reading as **R1**.

## Adjusting X-axis Sensitivity

1. Calculate the new value of the X-axis sensitivity.

$$\mathbf{TILTXS'} = \mathbf{K} \times \mathbf{TILTXS}$$

where

$$\mathbf{K} = \sqrt{\mathbf{1} + \mathbf{8.7} \times \mathbf{10}^{\mathbf{4}} \times \left( \frac{\mathbf{R0} - \mathbf{R1}}{\mathbf{X1}^{\mathbf{2}}} \right)}$$

and **X1** is in arcsec and **R0** and **R1** are in mGal.

2. Replace **TILTXS** by **TILTXS'** in the Autograv initial constants.
3. Repeat the measurement of the X-axis sensitivity to check that the adjustments are correct.

**Example:**

$$\mathbf{X1} = +155$$

$$\mathbf{R0} = 4236.52$$

$$\mathbf{TILTXS} = 195.3$$

$$\mathbf{R1} = 4236.56$$

therefore,

$$\mathbf{TILTXS'} = \sqrt{\mathbf{1} + \mathbf{8.7} \times \mathbf{10}^{\mathbf{4}} \times \left( \frac{\mathbf{-0.04}}{\mathbf{155}^{\mathbf{2}}} \right)} \times \mathbf{195.3}$$

$$\mathbf{TILTXS'} = 180.6$$

## Measuring Y-axis Sensitivity

1. Initialize the firmware by setting the following parameters.

Parameter	Setting
MODE	FIELD
READ TIME	120
TILT CORRECTION	SELECTED
TIDE CORRECTION	SELECTED
AUTO REJECTION	SELECTED
STOP: ERR. < LIM	DISABLED

2. Place the Autograv on the tripod in a quiet location with a solid floor (concrete is preferable). A wooden floor or carpet is *not suitable*.
3. Press the START key. The TILTS value appears on the display.
4. Level the instrument until  $Y = 0 \pm 10$  and  $X = 0 \pm 10$ .
5. Take a reading and record it as **R0**.
6. Adjust the tripod until  $Y = 0 \pm 150$  and  $X = 0 \pm 5$ .
7. Wait for 5 minutes and then note the exact value (**Y1**) as shown on the display.
8. Take a reading and record the reading as **R1**.

## Adjusting Y-axis Sensitivity

1. Calculate the new value of the Y-axis sensitivity.

$$\mathbf{TILTXYS'} = \mathbf{K} \times \mathbf{TILTXYS}$$

where

$$\mathbf{K} = \sqrt{\mathbf{1} + \mathbf{8.7} \times \mathbf{10}^4 \times \left( \frac{\mathbf{R0} - \mathbf{R1}}{\mathbf{Y1}^2} \right)}$$

and **Y1** is in arcsec and **R0** and **R1** are in mGal.

2. Replace **TILTYS** by **TILTYS'** in the Autograv initial constants.
3. Repeat the measurement of the Y-axis sensitivity to check that the adjustments are correct.

Example:

$$\mathbf{Y1} = +155$$

$$\mathbf{R0} = 4236.52$$

$$\mathbf{TILTYS} = 195.3$$

$$\mathbf{R1} = 4236.56$$

therefore,

$$\mathbf{TILTXYS'} = \sqrt{\mathbf{1} + \mathbf{8.7} \times \mathbf{10}^4 \times \left( \frac{-\mathbf{0.04}}{\mathbf{155}^2} \right)} \times \mathbf{195.3}$$

$$\mathbf{TILTYS'} = 180.6$$

## TILT SENSOR CROSS-COUPLING

This adjustment reduces cross-coupling between the tilt sensors and reduces the effect that an adjustment about the X-axis has on the output of the Y sensor. It enables you to level the Autograv more quickly by following the steps in the *Getting Started* section. The cross-coupling should be very stable and only needs to be measured and adjusted as required.

### Measuring

1. Place the Autograv on the tripod in a quiet location with a solid floor (concrete is preferable). A wooden floor or carpet is not suitable.
2. Rotate the tripod footscrews eight turns up from their bottom positions.
3. Press the **START** key to set the Autograv into the **ADJUST** mode and level the instrument until  $X = 0 \pm 10$ ,  $Y = 0 \pm 1$ .
4. Wait 5 minutes and observe the Y-tilt. Record the value as **Y0**.
5. Rotate the front footscrews *clockwise* five turns. Observe the Y-tilt and record the value as **Y1**.
6. Rotate the front footscrews *counter-clockwise* five turns. Observe the Y-tilt and record the value as **Y2**.
7. The cross coupling specification is:

$$|Y2 - Y0| < 5$$

$$|Y1 - Y0| < 5$$

If this specification is not met, then proceed with the steps as outlined in the following *Adjustment* section.



## Adjusting

1. Place the Autograv on the tripod in a quiet location with a solid floor (concrete is preferable). A wooden floor or carpet is not suitable.
2. On a piece of protective foam, lay the Autograv down on its front and view the bottom of the instrument. See figure below:

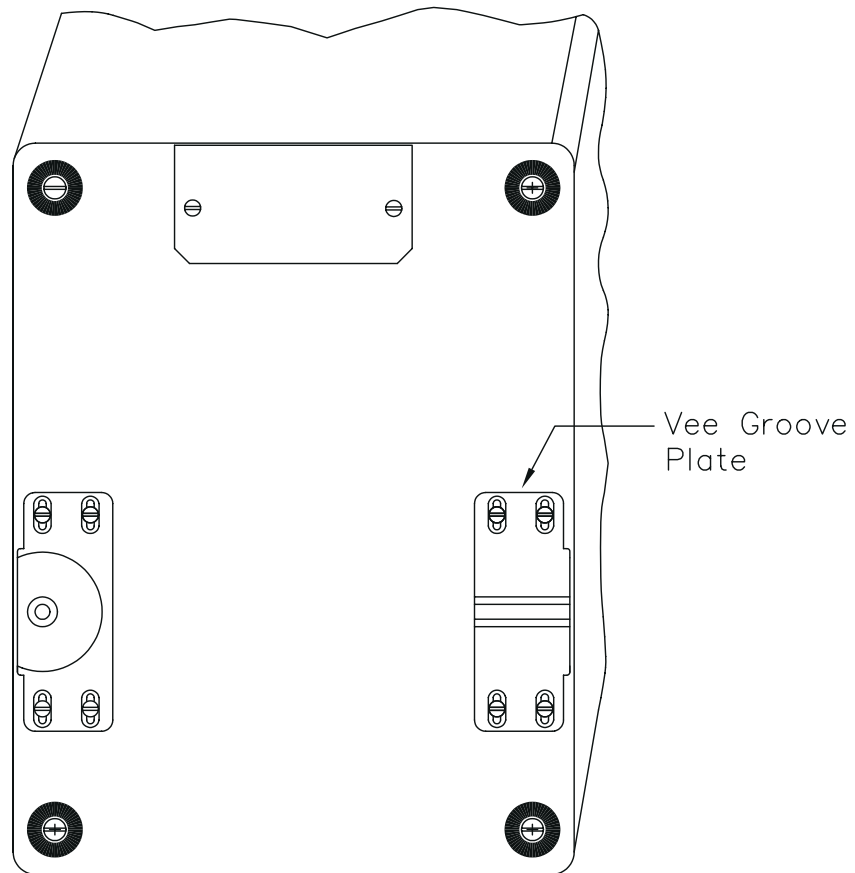

**Figure 17** Bottom of Autograv

3. Loosen the four screws on the Vee groove plate (slot side) until the plate can just slide freely.
4. Raise the tripod feet *eight* (8) turns from their bottom positions.

---

## Maintenance

5. Place the instrument onto the tripod.
6. Press the **START** key to place the instrument into the **ADJUST** mode.
7. Level the instrument until  $X = \pm 10$ ,  $Y = \pm 1$
8. Wait 5 minutes and observe the  $Y$ -tilt. Record the value as **Y0**.
9. Rotate the front footscrew *clockwise* five turns. Observe the  $Y$ -tilt output.
10. Hold the tripod in place as it must not move during this step. Rotate the instrument on the tripod until  $Y = Y0 \pm 5$  (if  $Y < 0$ , then rotate instrument *clockwise*). The Vee groove block should slide relative to the case. If possible, have a second person hold the tripod.
11. Tighten the four screws on the Vee groove plate.
12. Repeat steps **8** and **9**. The difference in  $Y$  (i.e.  $Y0 - Y$ ) should be less than 5 seconds. If it is not within this range, then repeat the adjustment procedure.

# RECALIBRATING THE GRAVIMETER

As explained on page A-10, the calibration factors **GCAL1** and **GCAL2** are applied to the gravity signal, according to the Equation (A.4) on page A-10. The calibration factor **GCAL2**, which accounts for a small quadratic nonlinearity, is evaluated in the Scintrex gravity laboratory. Since 1991, it has been reduced to zero by an electronic adjustment. The **GCAL2** need not be re-evaluated.

The main calibration constant, **GCAL1**, is determined on the Orangeville Calibration Line, 70 km north of Toronto. This line, which includes two absolute stations, was established and is maintained by the Geological Survey of Canada. The section used for the CG-3 calibration and testing consists of 5 stations spread over a distance of 70 km covering a gravity interval of 106 mGal (recently modified to 119 mGal). Instruments are transported by car, strapped onto the back seat with no special transport case or fixtures.

Readings are taken at each station on the way up the line and repeated on the way down. Readings of  $DUR = 60$  seconds are taken. Earth tide corrections are made automatically with the instrument's built-in program.

---

## Recalibrating the Gravimeter

A linear residual drift correction is applied, off line, on the basis of repeat readings at station **1**. The difference  $S_{ij}$ , between drift corrected readings at station **1** and station **j** is then calculated. The measurement error for a gravity difference is defined as

$$E_{ij} = k * S_{ij} - g_{ij}$$

where  $g_{ij}$  are the reference gravity differences and **k** is a constant (the scale correction factor) which is varied until the standard deviation of the measurements errors is minimized. The new scale factor **GCAL1'** is then calculated from the old value **GCAL1** used during the calibration test as

$$GCAL1' = k * GCAL1$$

The accuracy of the **GCAL1** determination is about 0.01% (0.01 mGal measurement error in 106 mGal gravity test range).

The **GCAL1** stability depends on the dimensional stability of the capacitive displacement transducer, and the stability of the internal D.C. reference voltage. After the initial period of a few months, during which the **GCAL1** may change, due to the stress relaxation effects in the newly fused quartz sensor, by up to 0.1%, the drift rate of the scale factor **GCAL1** is commonly 1 to 2 ppm (parts per million) per day. After a few years, users requiring greatest precision, in particular for regional surveys, may wish to recalibrate their gravimeters. This could be done in a similar way as it was done initially at Scintrex.

In order to derive the new **GCAL1** at least two locally available stations with the reliably determined gravity difference of at least 100 mGal are necessary. Additional intermediate well determined gravity stations will serve to increase the precision of this determination. By looping back to the starting station the residual drift should be determined, and used for correction of readings at other stations. Beware that some older calibration ranges were established by using LaCoste-Romberg gravimeters before the existence of cyclic measurement screw errors was known and the corrections for it applied, and that therefore they may not be very accurate.

## TRIPOD MAINTENANCE



The tripod footscrew adjustment threads are protected by a stainless steel sleeve at the tripod base and a plastic wiper in the bottom of each footscrew. The stainless steel sleeve should be periodically maintained by winding the tripod footscrews to the top of their travel, and then cleaning and lightly oiling the sleeve.

## STORING THE AUTOGRAV



There are several steps that you *must* follow in order to obtain the best results from your instrument:

- ▲ Level the Autograv
- ▲ Always keep the Autograv connected to the powered up battery charger when not in use.
- ▲ Store the Autograv with the powered up battery charger in a dry, secure place.
- ▲ During storage, remove the battery compartment door to prevent a buildup of gases which could vent from the battery.

# TROUBLESHOOTING

The following is a brief outline of problems, possible causes and possible remedies to aid you in the event of system failures. Follow the natural progression of steps that is shown below for troubleshooting the Autograv.

Problems	Possible Causes	Possible Remedies
<b>Autograv will not power up</b>	Battery is depleted.	Plug in charger and charge battery.
	Battery compartment fuse is blown	Replace battery compartment fuse. (See Figure 14 on page 5-8)
	Charger is not connected.	Connect charger cable to the Autograv connector.
	Charger is not plugged in.	Plug charger into AC outlet.
<b>Charger light does not come on</b>	Charger is not plugged in.	Plug into AC outlet.
	Charger fuse is blown.	Install correct fuse. (See page 5-5)
<b>Keypad does not work</b>	Display is stuck.	Reset the Autograv by pressing the ON/OFF key for more than 5 seconds.
<b>Reading appears to be out of range or reading is close in value to GCAL1 and ERR/SD is low.</b>	Sensor may be latched	1. Gently tap the upper panel underneath the Autograv name with your finger several times.
		2. Take a new reading so that the instrument does not average the incorrect reading.
		3. If the reading is still incorrect, repeat the steps increasing the number of taps until the sensor unlatches.

## Troubleshooting

<b>Problems</b>	<b>Possible Causes</b>	<b>Possible Remedies</b>
<b>Analog tilt meter at one end of range while digital tilt readout close to zero.</b>	Meter needle may be latched.	Gently tap the meter until the meter-needle unlatches.
<b>Battery does not charge</b>	Needs new battery.	Replace with new battery and charge with the charger as outlined in the <i>Getting Started</i> section.
	Battery compartment fuse is blown	Replace battery compartment fuse — 3A fast acting (See Figure 14 on page 5-8)
<b>Display changes slowly</b>	Ambient temperature is too cold for the display to operate properly	Keep console warm. Purchase optional display heater.
<b>Memory loss after Autograv is turned off</b>	Miniature batteries on memory board need replacement	Send Autograv Control Console to Scintrex Limited for repair.
<b>Auxiliary Mode locked</b>	Instrument needs to be reset	Press the ON/OFF key while the Autograv is turned on, for more than five seconds to reset the CG-3.
<b>Cannot dump data</b>	<ul style="list-style-type: none"> <li>▲ NORMAL/REVERSE switch</li> <li>▲ adaptor not used</li> <li>▲ faulty RS232C cable</li> <li>▲ wrong computer settings or component used</li> </ul>	<ol style="list-style-type: none"> <li>1. Read Appendix C.</li> <li>2. Check RS232C cable.</li> <li>3. Check that the Autograv and computer communications parameters are the same.</li> </ol>

# REFERENCE INFORMATION

## AUTOGRAV SPECIFICATIONS

<b>Reading Resolution:</b>	CG-3: 0.005 milligal CG-3M: 0.001 milligal
<b>Minimum Operating Range:</b>	7000 milligals, without resetting.
<b>Residual Long-term Drift:</b>	Less than 0.02 milligal/day.
<b>Typical Repeatability in field use:</b>	CG-3: less than 0.01 mGal standard deviation. CG-3M: less than 0.05 mGal standard deviation
<b>Range of Automatic Tilt correction:</b>	±200 arc sec.
<b>Dimensions:</b>	240mm x 310mm x 320mm.
<b>Weight:</b>	11 kg, including standard battery.
<b>Power Consumption:</b>	5 W at +25°C.
<b>Operating Temperature Range:</b>	-40°C to +45°C. Optionally high temp. to +55°C.
<b>Interval Between Readings in CYCLING Mode:</b>	Adjustable from 6 to 99999 seconds
<b>Standard Memory:</b>	48K RAM internal solid-state memory records up to 1290 gravity observations. .

---

## Reference Information

---

<b>Noise Rejection:</b>	Samples of more than 4 standard deviations from the average are rejected, if this feature is selected upon initialization of the instrument.
<b>Displayed and Recorded Data:</b>	Corrected Gravity, Standard Deviation, Tilt about the X-axis, Tilt about the Y-axis, Gravity Sensor Temperature, Tidal Correction, Duration of Measurement, Time at start of measurement and Header Information (including date and initialization constants).
<b>Digital Display:</b>	80 character, 4 line LCD display.
<b>Keypad Input:</b>	14 keys for entering all commands, co-ordinates, header and ancillary information
<b>Real Time Clock:</b>	Day, month, year, hour, minute and second.  One second resolution, one second stability over 24 hours over the operating temperature range.
<b>Digital Data Output:</b>	RS-232C serial interface. Data outputs in 7 or 8 bit ASCII, one start, two stop bits, no parity format. Baud rate is selectable at 110, 300, 600, 1200 and 2400 baud. Carriage return delay is keyboard selectable in increments of one from 0 to 999. X-ON/X-OFF handshaking protocol.

---



## STANDARD ACCESSORIES

<b>Tripod:</b>	Gravity meter tripod with built-in bubble level — 1.0 kg, 0.5 m leg extensions —1.0 kg.
<b>Battery:</b>	Two 7.2 Ah; 2.2 kg.
<b>Battery Charger:</b>	115/230V AC; 50/60 Hz
<b>Carrying Bag:</b>	
<b>Communications:</b>	RS-232 cable, adaptor and IDUMP software
<b>RS-232C Cable and Adaptor:</b>	Includes a special RS-232C data transfer cable and adaptor. Used for communicating with peripheral devices.
<b>Display Heater:</b>	Required for cold weather operation. Powered by main batteries, thermostatically controlled to turn off above -20°C
<b>Minor Spare Parts Kit:</b>	
<b>Operations Manual:</b>	

## OPTIONAL ACCESSORIES

<b>Belt Battery Pack:</b>	The operator wears the Belt Battery Pack inside their coat during cold weather to keep rechargeable batteries warm. This extends the lifetime of the batteries.
<b>Chart Recorder Cable:</b>	This cable interfaces with any standard chart recorder
<b>External Power Cable:</b>	Required for operation of the instrument from an external 12V DC power supply or battery

---

## Reference Information

<b>Backpack:</b>	For transporting the CG-3 over long distances or in difficult terrain.
<b>High Temperature Option:</b>	For operating up to +55°C
<b>Elevation Options:</b>	Scintrex can provide a variety of devices for elevation and positional control.
<b>Peripheral Devices:</b>	Scintrex can recommend and supply suitable digital printers, microcomputers, modems and other peripherals.

---

# APPLICATION SOFTWARE

Scintrex supplies fully documented software written for the IBM family of microcomputers, and certain other microcomputers which use the MS-DOS<sup>®</sup> operating system.

This software permits:

- ▲ data reduction
- ▲ archiving of data
- ▲ processing of data
- ▲ profile and contour plotting
- ▲ modelling

# TRAINING

Scintrex can provide detailed training programs for the CG-3 including operation, basic maintenance and data processing.

# INSTRUMENT PARTS LIST

## CG-3 GRAVITY METER AND STANDARD ACCESSORIES

Description	Part Number
<b>CG-3 Gravity Meter (includes:)</b>	858 011
<b>Case</b>	858 012
<b>Sensor</b>	858 013
<b>Tripod</b>	858 076
<b>Cover</b>	858 077
<b>Battery Charger</b>	858 091
<b>Console</b>	858 092
<b>Transport Case</b>	858 095
<b>Carrying Strap</b>	858 099
<b>Manuals</b>	858 700
<b>RS-232C Cable</b>	780 549
<b>RS-232C Cable Adaptor</b>	780 541
<b>RS-232C Female-Female Gender Converter</b>	211 150
<b>Minor Spare Parts Kit</b>	858 028
<b>Carrying Bag</b>	140 260
<b>Battery</b>	858 079
<b>Display Heater Kit</b>	780 031

Reference

## OPTIONS

Description	Part Number
<b>Battery Pack Belt</b>	858 093
<b>Chart Recorder Cable</b>	780 542
<b>External Power Cable</b>	858 078
<b>Back Pack</b>	858 021

---

Reference Information

## SPARE PARTS KIT

<b>Description</b>	<b>Quantity</b>	<b>Part Number</b>
<b>Fuse - Fast Acting - 3 Amp</b>	2	512 020
<b>Fuse - Slow Blow - 0.75 Amp</b>	2	512 039
<b>Fuse - Slow Blow - 0.375 Amp</b>	2	512 041
<b>Screw Driver - 5/32"</b>	1	540 062
<b>Screw Driver - 3/16"</b>	1	540 063
<b>Screw Driver - Jewellers Set</b>	1	540 064
<b>Allen Wrench - 7/64"</b>	1	540 065

# WARRANTY AND REPAIR

## WARRANTY

All Scintrex equipment, with the exception of consumable items, is warranted against defects in materials and workmanship for a period of one year from the date of shipment from our plant. Should any defects become evident under normal use during this warranty period, Scintrex will make the necessary repairs free of charge.

This warranty does not cover damage due to misuse or accident and may be voided if the instrument console is opened or tampered with by persons not authorized by Scintrex Limited.

To validate the warranty, the warranty card supplied with the instrument must be returned to Scintrex within 30 days of shipment from our plant.

## REPAIR

### When to Ship the Unit

Please do not ship your instrument for repair until you have communicated the nature of the problem to our Customer Service Department by facsimile, telephone or letter, etc. Our Customer Service Department may suggest certain simple tests or steps for you to do which may solve your problem without shipping the instrument back for repair. If the problem cannot be resolved, our personnel will request that you send the instrument to our plant for necessary repairs.

---

## Reference Information

### Description of Problem

When you describe the problem, include the following information:

- ▲ the symptoms of the problem
- ▲ how the problem started
- ▲ if it is constantly present, intermittent or repeatable
- ▲ if constant, under what conditions it occurs
- ▲ a printout of measurement data demonstrating the problem
- ▲ the initial constants that were used with the instrument

Please mention the instrument serial number in all communications regarding equipment leased or purchased from Scintrex.

### How to Ship the Unit

No instrument will be accepted for repair unless it is shipped prepaid. After repair it will be returned collect.

Ensure that you unplug the battery from the unit and send it with the instrument. In the case of a short battery life or possible battery problems, the charger should also be returned for diagnosis/repair.

Instruments shipped for repair from outside Canada should be addressed to:

**Scintrex Limited**  
**c/o DANZAS, Customs Brokers**  
**Lester B Pearson (Toronto) International Airport**  
**Canada**

Scintrex instruments are manufactured in Canada. Consequently, there is no customer duty payable in Canada. It is advisable to state on customs documents:

#### **Canadian Goods Returned to Canada for Repair**

Shipments should be made by air in the original shipping case to minimize the possibility of damage in transit. Within Canada, ship by air directly to:

**Scintrex Limited**  
**222 Snidercroft Road**  
**Concord, ON L4K 1B5**

# THEORY OF OPERATION

## INTRODUCTION

The sensing element of the Autograv is based on a fused quartz elastic system. The gravitational force on the proof mass is balanced by a spring and a relatively small electrostatic restoring force. The position of the mass, which is sensed by a capacitive displacement transducer, is altered by a change in gravity. An automatic feedback circuit applies DC voltage to the capacitor plates producing an electrostatic force on the mass which brings it back to a null position. The feedback voltage, which is a measure of the relative value of gravity at the reading site, is converted to a digital signal and then transmitted to the instrument's data acquisition system for processing, display and storage. The position of the center of gravity of the proof mass relative to the case of the perimeter is shown in Figure A-1 on page A-2.

The inherent strength and excellent elastic properties of fused quartz together with limit stops around the proof mass permit the instrument to be operated without clamping. Further protection is provided by a durable shock mount system which attaches the sensor to the housing.

The parameters of the gravity sensor and its electronic circuits are chosen so that the feedback voltage covers a range of over 7000 mGals without resetting. The use of a low-noise electronic design, together with a highly accurate auto-calibrating analog to digital converter, results in a resolution of either 0.005 or 0.001 mGal, equipping the gravity meter for both detailed field investigations and large scale regional or geodetic surveys.

---

## Theory of Operation

The instrument's tilt sensors are also electronic, with a resolution of 1 arc second. The outputs from the sensors are displayed on high resolution meters on the instrument's front panel and also transmitted to the data acquisition system where they are displayed and stored. If the instrument is operated on an unstable base, real-time corrections for tilt errors can be automatically made over a range of  $\pm 200$  arc seconds.

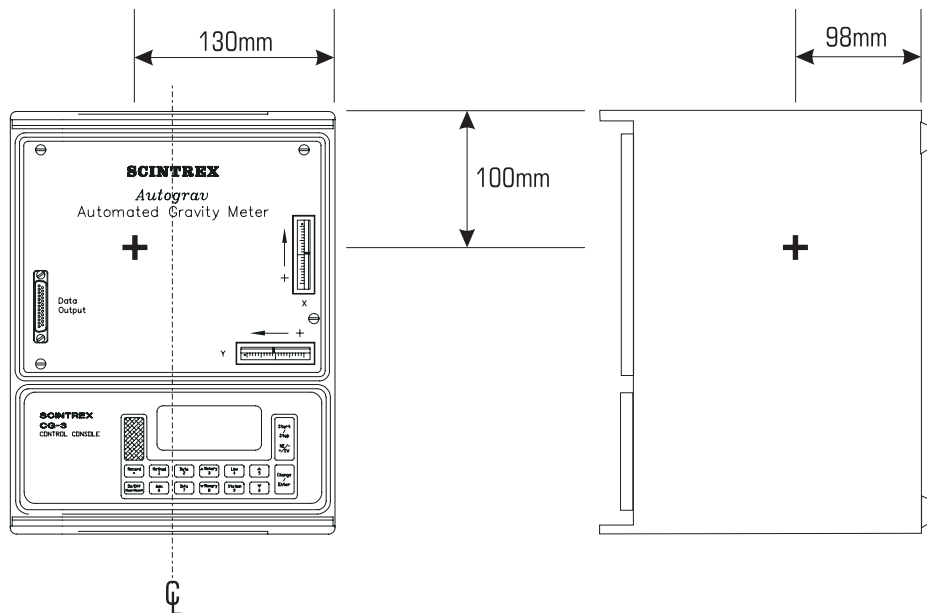

**Figure A—1** CG-3/3M Proof Mass Position

Protection from ambient temperature changes is provided by locating the quartz elastic system, the analog to digital converter, sensitive electronic components and the tilt sensors inside a high-stability, two stage, thermostatically controlled environment. There is no mechanical temperature compensation. External temperature changes are reduced by a factor of over  $10^4$  and small residual effects are corrected in software using the output of a sensor located in close thermal contact with the main spring. The operating range of the thermostat in the standard instrument is  $-40^{\circ}\text{C}$  to  $+45^{\circ}\text{C}$ . How-



---

## Introduction

ever, since there is no critical operating point for the sensor, the upper operating temperature can be set at a lower or higher value (optional +35°C or +55°C).

The entire gravity sensing mechanism is enclosed in a vacuum chamber. Since there are no mechanical feed-throughs, excellent isolation from variations in atmospheric pressure is obtained. This extremely stable operating environment for the quartz elastic system allows the long-term drift of the sensor to be accurately predicted, and real-time software correction reduces it to less than 0.02 mGals/day.

The sensor design is mechanically very simple. The fine balancing required to obtain astatation is not needed, as the displacement transducer has sufficient resolution (0.02nm) to detect the beam position of a non-astatised system, and electronic filtering reduces the effect of seismic noise. The mechanisms, micrometer screws, gearboxes and mechanical feed-throughs associated with mechanical feedback systems have been replaced by a voltage applied to the same plates which form the displacement transducer. The temperature control is also accurate enough for the sensor to operate without mechanical compensation.

# Theory of Operation

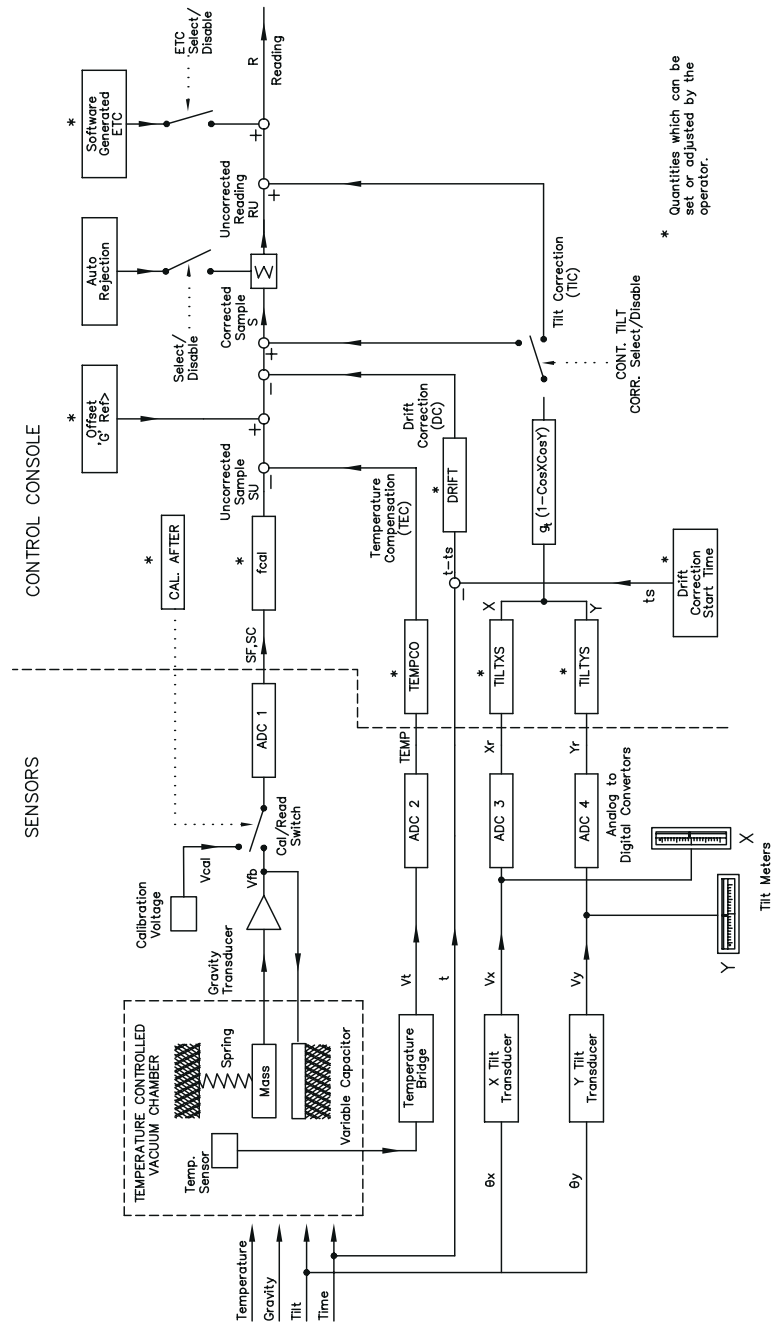

Figure A—2 Autograv Block Diagram of Signal Flow

## CONTROL CONSOLE AND SOFTWARE

The control console includes:

- ▲ 14-key dual function keypad
- ▲ 80 character LCD
- ▲ microprocessor
- ▲ solid state memory

### Console functions

It processes and applies corrections to the signals from the sensor, stores data, formats it for outputting and performs instrument control functions. A menu format with prompts is used to operate the instrument.

### Operating modes

The gravity meter has two modes of operation:

- ▲ **FIELD** mode, where readings are initiated by the operator
- ▲ **CYCLING** mode, where a series of readings are made automatically with an operator selected preset cycle time between each reading.

The software function is essentially the same in both modes.

### Console operation

The control console operation is based on a one second gating time. Once every second:

- ▲ analog signals are sampled
- ▲ the display is updated
- ▲ keypad commands are responded to
- ▲ and necessary control functions performed.

During a reading:

- ▲ the gravity signal  $V_{fb}$  is sampled once every second by ADC1 (see Figure A-2 on page A-4).
- ▲ The individual samples are averaged to filter out seismic noise.
- ▲ A running mean of the samples is displayed together with its standard deviation.
- ▲ In the course of a reading, the input of ADC1 is periodically switched to the calibration voltage ( $V_{cal}$ ). The frequency of calibration depends on the operating conditions and is determined by the operator before the reading starts.

---

## Theory of Operation

- ▲ A reading is stopped either by the operator or when a preset time or estimated standard deviation of the mean is reached.
- ▲ Corrections for tilts and long-term drift are made every second during the reading.
- ▲ A statistical rejection criterion is used to discard any noise spikes.
- ▲ A tide and temperature correction is applied at the end of the reading. The tilt and tide correction features can be disabled via the keypad.

When a measurement is completed, the gravity reading is stored in the memory along with the following nine other variables.

1. station number
2. standard deviation of the mean of 1 second samples
3. tilt X
4. tilt Y
5. sensor temperature
6. tide correction applied
7. reading duration
8. number of rejected samples
9. time of start of reading

All current and stored data can be viewed on the LCD by using the scroll feature on the keypad.

Additional information can be entered at the time of measurement for recording in memory. Eight blocks of data, each containing up to a five-digit signed number can be stored with each reading.

The standard memory stores up to 1290 readings. The memory is protected for several days in the event of a battery failure.

Other information is also generated and is accessible through the display, including time, date, battery voltage and available memory space.

The instrument is equipped with an RS-232 interface. This enables data from the memory to be accessed through a connector on the instrument front panel. Output of selected portions or of the entire contents of the memory can be obtained in the form of a data listing or as a plot, which can be printed out directly onto a line printer, transferred to a portable computer or tape recorder or transmitted over a telephone line with a modem.

# SPRING SERVICE LIFE AND READING RANGE

The uncorrected gravity reading is obtained as shown from Equation (A.4) on page A-10. The gravity reading range has high and low end, the range of which is guaranteed to be 7000 mGal, but is normally much larger. The low end of the gravity measurement range of the CG-3 may be calculated by inserting value  $(SF/SC) = 0.1$  into Equation (A.4)

$$SU_{\min} = 0.1 * GCAL1 + 0.01 * GCAL2 \quad (A.1)$$

The average value of  $SU_{\min}$  is about 600 mGal. Depending on the values  $GCAL1$  and  $GCAL2$  this value may differ somewhat for your meter. It is recommended that you calculate this value for your meter, because the gravity readings of lower values than  $SU_{\min}$  may not be accurate.

The high end of the gravity measurement range may be calculated by inserting value  $(SF/SC) = 1.457$  into Equation (A.4)

$$SU_{\max} = 1.457 * GCAL1 + 2.123 * GCAL2 \quad (A.2)$$

The average value of  $SU_{\max}$  is about 8800 mGal. Depending on the values  $GCAL1$  and  $GCAL2$  this value may differ somewhat for your meter. It is recommended that you calculate this value for your meter, because the gravity readings of the higher value than  $SU_{\max}$  may not be accurate.

The CG-3 sensor spring position is adjusted during the sensor manufacture in such a way that, on the average, the gravity reading in Toronto (latitude 43.7 degrees) is about 4200 mGal. This, in conjunction with the gravity reading range of about 8000 mGals, assures that newly produced CG-3 may measure the relative gravity anywhere on the surface of the earth, from elevations of a few thousand meters above the equator to sea levels at both poles. For your convenience, values of normal gravity at sea level, as a function of latitude, are listed in Table I on page A-9.

---

## Theory of Operation

Because of the positive drift rate of the CG-3 gravity sensor, the uncorrected gravity readings at the fixed locations gradually increase in value. The linear drift of the CG-3 sensor is caused by an unavoidable creep of the quartz spring, whose length under tension increases, on the average, by 0.5 ppm/day at the operating temperature of 60°C. A typical sensor with the drift rate of 0.5 mGal/day will reach the high end of the measurement range, at the latitude of 60 degrees, in about 20 years. If used at lower latitudes, as most gravimeters are, the typical CG-3 service life will be even longer.

You may estimate the remaining service life of your meter in the following way:

- a. Calculate the value  $SU_{max}$  for your meter.
- b. Obtain the gravity reading at your location.
- c. If you are planning to use your meter at higher latitudes than your present latitude, evaluate from Table I the gravity difference between your present latitude and the highest latitude at which you will be using your meter. Add this difference to the reading obtained in Step b. to obtain the value  $SU_m$ .
- d. The remaining service life expressed in days is calculated by dividing the difference ( $SU_{max} - SU_m$ ) by the value of the linear drift rate of your CG-3.

- Example:**
1. You have calculated for your meter from Equation (A.2) on page A-7:  $SU_{max} = 8800$  mGal
  2. The drift rate of your meter is: 0.51 mGal/day.
  3. Assuming that you are at latitude of 50°.
  4. You have measured  $SU = 5012$  mGal.
  5. Assuming that you will be using your meter up to latitudes of 60°.
  6. Giving  $SU_m = (5012 + 847)$  mGal, (see Step c.).
  7. Then the number of remaining service days is:  
 $(8800 - 5012 - 847)/0.51 = 5767$ .

## Spring Service Life and Reading Range

$$g = g_e \times [(1 + b \times \sin^2\theta) - (b1 \times \sin^2(2\theta))] \quad \text{gravity at latitude } \theta \quad (\text{A.3})$$

where:  $g_e = 978.03268$  (Gal), gravity at the equator  
 $b = 0.00503244$   
 $b1 = 0.0000058$   
 $\theta = \text{latitude}$

**Table I: Normal Gravity at Sea Level (Torge, 1989 p.51)**

Lat. $\theta$	$g$ (Gal)	$g - g_e$ (mGal)	Lat. $\theta$	$g$ (Gal)	$g - g_e$ (mGal)	Lat. $\theta$	$g$ (Gal)	$g - g_e$ (mGal)
0	978.032680	0.000	30	979.324915	1292.235	60	981.917895	3885.215
1	978.034253	1.573	31	979.403907	1371.227	61	981.995650	3962.970
2	978.038969	6.289	32	979.484390	1451.710	62	982.071737	4039.057
3	978.046823	14.143	33	979.566266	1533.586	63	982.146062	4113.382
4	978.057805	25.125	34	979.649436	1616.756	64	982.218535	4185.855
5	978.071902	39.222	35	979.733799	1701.119	65	982.289066	4256.386
6	978.089098	56.418	36	979.839254	1786.574	66	982.357569	4324.889
7	978.109371	76.691	37	979.905696	1873.016	67	982.423960	4391.280
8	978.132697	100.017	38	979.993021	1960.341	68	982.488156	4455.476
9	978.159048	126.368	39	980.081122	2048.442	69	982.550080	4517.400
10	978.388392	155.712	40	980.169892	2137.212	70	982.609654	4576.914
11	978.220695	188.015	41	980.259224	2226.544	71	982.666806	4634.126
12	978.255916	223.236	42	980.349009	2316.329	72	982.721465	4688.785
13	978.294015	261.335	43	980.439138	2406.458	73	982.773564	4740.884
14	978.334944	302.264	44	980.529500	2496.820	74	982.823038	4790.358
15	978.378655	345.975	45	980.619987	2587.307	75	982.869828	4837.148
16	978.425095	392.415	46	980.710488	2677.808	76	982.913875	4881.195
17	978.474208	441.528	47	980.800892	2768.212	77	982.955125	4922.445
18	978.525935	493.255	48	980.891089	2858.409	78	982.993526	4960.846
19	978.580214	547.534	49	980.980970	2948.290	79	983.029033	4996.353
20	978.636978	604.298	50	981.070424	3037.744	80	983.061600	5028.920
21	978.696160	663.480	51	981.159343	3126.663	81	983.091188	5058.508
22	978.757689	725.009	52	981.247618	3214.938	82	983.117761	5085.081
23	978.821489	788.809	53	981.335140	3302.460	83	983.141285	5108.605
24	978.887485	854.805	54	981.421804	3389.124	84	983.161732	5129.052
25	978.955596	922.916	55	981.507502	3474.822	85	983.179075	5146.395
26	979.025740	993.060	56	981.592131	3559.451	86	983.193295	5160.615
27	979.097832	1065.152	57	981.675586	3642.906	87	983.204373	5171.693
28	979.171785	1139.305	58	981.757765	3725.085	88	983.212296	5179.616
29	979.247510	1214.830	59	981.838568	3805.888	89	983.217053	5184.373
30	979.324915	1292.235	60	981.917895	3885.215	90	983.218640	5185.960

---

## Theory of Operation

If, after many years of service, your CG-3 has drifted out of range, then the spring position may be reset by a routine procedure at the Scintrex plant. You may also use this occasion to inquire about the available program to overhaul your meter, to upgrade to the latest firmware version or to upgrade to the CG-3M accuracy level (if the evaluation at Scintrex shows that the quality of your sensor warrants such an upgrade).

# PROCESSING OF THE GRAVITY SIGNAL

While reading this section, please also refer to the *Signal Flow* diagram in Figure A-2 on page A-4.

The input to the gravity analog to digital converter (ADC1) is switched between  $V_{fb}$ , the gravity transducer output and  $V_{cal}$ , the stable calibration voltage. When the instrument is in the **ADJUST** mode (after the **START** key is pressed once), the calibration voltage is connected to ADC1. In this mode, the value of  $V_{cal}$  can be viewed on the display under the heading **GRAV**.

In the **READ** mode, (after the **START** key is pressed a second time) the input to ADC1 is held at  $V_{cal}$  for one second (during **PAUSE**) then switched to  $V_{fb}$  for  $x$  one second samples. It is then switched back to  $V_{cal}$  for one sample then to  $V_{fb}$  for  $x$  samples and so on until the reading is terminated. The value of  $x$  is entered under the Autograv setup at the **CAL AFTER** prompt. The output of ADC1 is termed **SC** when  $V_{cal}$  is applied and **SF** when the  $V_{fb}$  is applied.

### Uncorrected sample

The calibration voltage and other calibration factors are then applied to the gravity signal by the function  $f_{cal}$  in order to give an uncorrected sample

$$SU = f_{cal}(SC, SF) = GCAL1\left(\frac{SF}{SC}\right) + GCAL2\left(\frac{SF}{SC}\right)^2 \quad (A.4)$$

**SF** is divided by the most recent value of **SC** to correct for any drift in the scale factor of ADC1. The factors **GCAL1** and **GCAL2** are the instrument calibration factors which are entered via the keypad. They take into account a small quadratic non-linearity inherent in the ADC and in the conversion from electrostatic feedback voltage to force.



## Processing of the Gravity Signal

### Corrected sample

The uncorrected sample has drift correction and **GREF** applied and if selected, then also the tilt correction, to give a corrected sample

$$\mathbf{S} = \mathbf{SU} - \mathbf{DC} + \mathbf{GREF} + \mathbf{TIC} = \mathbf{SU} + \mathbf{C} \quad (\text{A.5})$$

A running average of corrected samples (the function  $\Sigma$  in Figure A-2 on page A-4) gives the corrected reading

$$\mathbf{RU}_{ij} = \frac{\sum_{i=1}^y \sum_{i=1}^x \mathbf{GCAL1} \left( \frac{\mathbf{SF}_{ij}}{\mathbf{SC}_j} \right) + \mathbf{GCAL2} \left( \frac{\mathbf{SF}_{ij}}{\mathbf{SC}_j} \right)^2 + \mathbf{C}_{ij}}{(\mathbf{j} - 1)\mathbf{x} + \mathbf{i} - \mathbf{NR}} = \frac{\sum_{i=1}^y \sum_{i=1}^x (\mathbf{S}_{ij} + \mathbf{C}_{ij})}{\mathbf{DUR}} \quad (\text{A.6})$$

Where  $\mathbf{SC}_j$  is the value of the  $\mathbf{j}^{\text{th}}$  voltage calibration and  $\mathbf{SF}_{ij}$  and  $\mathbf{C}_{ij}$  are the  $\mathbf{i}^{\text{th}}$  gravity sample and correction after the  $\mathbf{j}^{\text{th}}$  voltage calibration.

### Standard deviation

The standard deviation (**SD**) of the corrected samples is calculated every second and samples which are *more than four standard deviations from  $\mathbf{RU}_{ij}$  are rejected*. This **AUTO REJECT** feature can be disabled via the keypad. The **SD** is displayed every time the instrument calibrates itself, e.g. every 12 seconds, if **CAL AFTER** value 12 is selected. It is recorded and output, as well. It is the measure of signal noisiness, which includes the instrumental and ambient seismic noise.

The current value of  $\mathbf{RU}_{ij}$  is shown on the top line of the display during the reading period and the current sample number

$$\mathbf{DUR} = (\mathbf{j} - 1)\mathbf{x} + \mathbf{i} - \mathbf{NR} \quad (\text{A.7})$$

where **NR** is the number of rejections. On the right hand side of the second line the display alternates between the latest value of the **SD** during calibration sampling and the standard deviation of the mean, which is estimated under the assumption that the noise is *normally* distributed (i.e. white) from the relationship:

$$\mathbf{ERR} = \frac{\mathbf{SD}}{\sqrt{\mathbf{DUR}}} \quad (\text{A.8})$$

during gravity sampling.

---

## Theory of Operation

The formula given in Equation (A.8) is the one used in the CG-3. However, during periods of high seismicity (caused by microseismic noise), the standard deviation of the mean is better estimated by

$$\mathbf{ERR} = \frac{\mathbf{SD}}{\mathbf{DUR}} \quad (\text{A.9})$$

Consequently, the measurement duration (**DUR**) evaluated by (9.5) to make **ERR < ERR LIM** are too long. It is therefore suggested, that the function to terminate the measurement when the estimated error value is less than the specified limit is not used if the **SD** is greater than 0.04 mGal. It is better to extend the measurement time to 120 seconds if microGal precision is required during periods of high ambient seismicity.

### Displayed reading

Sampling of the gravity signal stops when either **DUR** reaches the preset **READ TIME**, when **ERR < ERR LIM** or when the **START/STOP** key is pressed. Up to three further corrections: the tilt correction (**TIC**), the temperature correction (**TEC**) and the earth tide correction (**ETC**) are then added to **RU** to give the reading **R** which is then displayed.

$$\mathbf{R} = \mathbf{RU} + \mathbf{TIC} + \mathbf{ETC} - \mathbf{TEC} \quad (\text{A.10})$$

# COMPENSATION AND CORRECTIONS

## DRIFT CORRECTION

Long term instrument drift is largely due to stress relaxation in the elastic system. After an initial stabilization period, it can be considered a linear function of time. The effect of long term drift will be to produce a uniform change in reading with time. For example, Figure A-3 on page A-17 shows several days of continuous readings. If two uncorrected readings are taken at times **t<sub>1</sub>** and **t<sub>2</sub>\*** at a point where there has been no change in gravity, then the difference between them will depend on the long term drift rate, **d**, of the instrument and is:

---

\* **t<sub>n</sub>** is the midpoint between the start and finish of a reading

---

## Compensation and Corrections

$$\mathbf{RU}(\bar{\mathbf{t}}_2) - \mathbf{RU}(\bar{\mathbf{t}}_1) = \mathbf{d}(\bar{\mathbf{t}}_2 - \bar{\mathbf{t}}_1) \quad *$$
 (A.11)

To eliminate the effects of instrument drift, a drift correction

$$\mathbf{DC}(\mathbf{t}) = (\mathbf{t} - \mathbf{t}_s)\mathbf{DRIFT}$$
 (A.12)

is subtracted from each uncorrected sample **SU**.

**DRIFT** is the drift constant with units of mGal/24hrs,  $\mathbf{t}_s$  is the drift correction start time and  $\mathbf{t}$  is the time at which the samples are taken. Both **DRIFT** and  $\mathbf{t}_s$  are entered via the keypad.

With the drift correction applied, Equation (A.11) becomes:

$$\begin{aligned} \mathbf{R}(\bar{\mathbf{t}}_2) - \mathbf{R}(\bar{\mathbf{t}}_1) &= \mathbf{RU}(\bar{\mathbf{t}}_2) - \mathbf{DC}(\bar{\mathbf{t}}_2) - \mathbf{RU}\bar{\mathbf{t}}_1 + \mathbf{DC}(\bar{\mathbf{t}}_1) \\ &= (\mathbf{d}(\bar{\mathbf{t}}_2 - \bar{\mathbf{t}}_1) - \mathbf{DRIFT}(\bar{\mathbf{t}}_2 - \bar{\mathbf{t}}_1)) \end{aligned}$$
 (A.13)

If the drift correction is properly adjusted:

$$\begin{aligned} \mathbf{DRIFT} &= \mathbf{d} \\ \mathbf{R}(\bar{\mathbf{t}}_2) - \mathbf{R}(\bar{\mathbf{t}}_1) &= \mathbf{0} \end{aligned}$$
 (A.14)

The procedure for adjusting the drift correction is given in the *Getting Started* section starting on page 2-41.

## TILT CORRECTION (TIC)

The uncompensated gravity reading changes in response to tilt according to the following expression:

$$\mathbf{RU}(\theta_x, \theta_y) = \mathbf{RU}(\mathbf{0}, \mathbf{0}) - \mathbf{g}(1 - \cos\theta_x \cdot \cos\theta_y)$$
 (A.15)

$g$  is the value of gravity at the reading site and  $\theta_x$  and  $\theta_y$  are the tilts of the gravity sensor about two perpendicular horizontal axes (x and y) as shown in Figure 8 on page 2-32 with  $\theta_x = \theta_y = \mathbf{0}$  being defined as the orientation in which the uncompensated gravity meter reading is maximized.

---

\* calculation precision limits the maximum value of  $(\mathbf{t}-\mathbf{t}_s)$  to 4 months (128 days)

---

## Theory of Operation

The tilt correction operates over a range of  $\pm 200$  arcsec and is

$$\mathbf{TIC} = \mathbf{g}_t(1 - \cos \mathbf{x} \cdot \cos \mathbf{y}) \quad (\text{A.16})$$

where  $\mathbf{g}_t$  is an average sea level gravity value of 980.6 Gal and  $\mathbf{X}$  and  $\mathbf{Y}$  are the indicated gravity meter tilts.

Assuming  $\mathbf{g}_t = \mathbf{g}$  (this assumption leads to an error of 0.002 mGal in the worst case), the corrected reading will be:

$$\mathbf{R}(\theta_x, \theta_y) = \mathbf{RU}(\mathbf{0}, \mathbf{0}) - \mathbf{g}_t(\cos \theta_x \cdot \cos \theta_y - \cos \mathbf{x} \cdot \cos \mathbf{y}) \quad (\text{A.17})$$

If

$$\mathbf{x} = \theta_x \quad (\text{A.18})$$

$$\mathbf{y} = \theta_y$$

then

$$\mathbf{R}(\theta_x, \theta_y) = \mathbf{RU}(\mathbf{0}, \mathbf{0}) = \mathbf{R}(\mathbf{0}, \mathbf{0}) \quad (\text{A.19})$$

and errors due to instrument tilt are eliminated. The method used to adjust  $\mathbf{X}$  and  $\mathbf{Y}$  so that Equation (A.18) is satisfied, is given in the *Maintenance* section starting on page 6-4.

There are two software selectable modes of operating the tilt correction.

1. (CONT, TILT CORR - SELECTED), a correction is applied to each one second sample.
2. (CONT, TILT CORR - DISABLED), a correction is only applied at the end of the reading based on the X and Y values of the last one second sample of the reading.

The reason for two modes of operation is that the tilt sensors have a relatively fast response (typically a few seconds) up to within approximately 5 arcsec of the final value and then it takes up to a minute to come to within one arcsec of the final value.



If the Autograv is on a *solid base* and it does not move during the reading, then the **DISABLE** mode will give the most accurate result as the tilt sensors will have more time to settle before a compensation is applied.

If the instrument is on a *soft base* and moves during a reading, then it is preferable to select the continuous correction mode.

It should be noted that over a period of several hours, some tilt changes may arise from movement of the elastomer in the shock isolators (used to protect the sensor from severe shocks). This not relevant for the **FIELD** mode. In the **CYCLE** mode, however, these changes are corrected by the tilt correction function, regardless of whether or not the tilt correction function is enabled or disabled.

### TEMPERATURE COMPENSATION (TEC)

The fused quartz mainspring is the most temperature sensitive component in the gravity meter with a coefficient of approximately - 130 mGal/°C (spring becomes stronger as the temperature increases). This spring is protected from ambient temperature changes by a two stage thermostat which maintains the spring temperature  $T_s$  constant to within 0.5mK under normal operating conditions. The changes in  $T_s$  are measured using a temperature sensor in good thermal contact with the mainspring. The output of the temperature bridge is converted to a digital signal, **TEMP**, shown in Figure A-2 on page A-4 and this is converted to the temperature compensation signal.

$$\mathbf{TEC} = \mathbf{TEMPCO} \times \mathbf{TEMP} \quad (\text{A.20})$$

**TEMPCO** is the instrument temperature coefficient in mGal/mK. It is measured during the production of each instrument and is entered through the keypad. A new value of **TEC** is computed and applied after the last sample has been taken.

The spring temperature **TEMP** in units of mK can be displayed on the liquid crystal display. The last **TEMP** value for each reading is also stored in memory together with other measurement variables. The range of **TEMP** is  $\pm 3.0$  mK, and it is adjusted with a zero offset to within  $\pm 1.0$  mK for normal operation (See *Getting Started* section “Temperature Compensation” on page 2-35). This ensures that there is at least a 2.0 mK useful range to compensate for severe ambient temperature fluctuations.

---

## Theory of Operation

The chamber temperature is measured by a set of two thermistors, which themselves exhibit a long-term drift due to their aging. However, the effect of this drift is *indistinguishable* from the gravity sensor drift, and is corrected by the linear drift correction.

## EARTH TIDE CORRECTION (ETC)

The ETC is generated in the software via the Longman<sup>\*</sup> formula (gravimetric factor = 1.16) by entering in the latitude, longitude and difference between the gravimeter clock time and GMT from the keypad. It is applied after the last sample has been taken and it may also be disabled via the keypad. The time used in the tidal calculation is the midpoint between the start and the end of a reading.

It is critical that the GMT DIFF (see page 3-24) is properly input into the CG-3. If the sign is entered incorrectly, or the value is wrong because the local daylight savings time shifts (summer time) are not properly accounted for, then the resulting corrections will be poor.

## Residuals

The ETC will compensate for the gravity effects of the Sun and Moon to within (usually)  $\pm 3 \mu\text{Gals}$ . Tidal accelerations cause elastic deformations to the Earth's body (*earth body tides*). The average effect of this deformation is taken into account by the gravimetric factor 1.16 in the Longman formula (16% increase over the amplitude of gravimetric tides of the rigid Earth). Slight variances of gravimetric factor exist. The gravimetric factor is *latitude* dependent and different tidal waves have slightly different factors. This may result in minor residuals of a semi-diurnal and diurnal nature having amplitudes of about  $\pm 3 \mu\text{Gals}$ . In addition, the ocean tides, besides their direct gravitation, cause additional deformation by their loading. These deformations lead to additional changes of the gravity values observed on the surface of the Earth. The residuals from both effects could be effectively removed from field measurements by using another gravity meter as a base-station (Figure A-3 on page A-17).

---

<sup>\*</sup> Longman, I.M., Journal of Geophysical Research, Volume 64, No. 12, Formulas for Computing the Tidal Accelerations Due to the Moon and the Sun, December 1959

## GRAVITY OFFSET (GREF)

This value is in mGal and entered from the keypad. It is added to each reading sample.

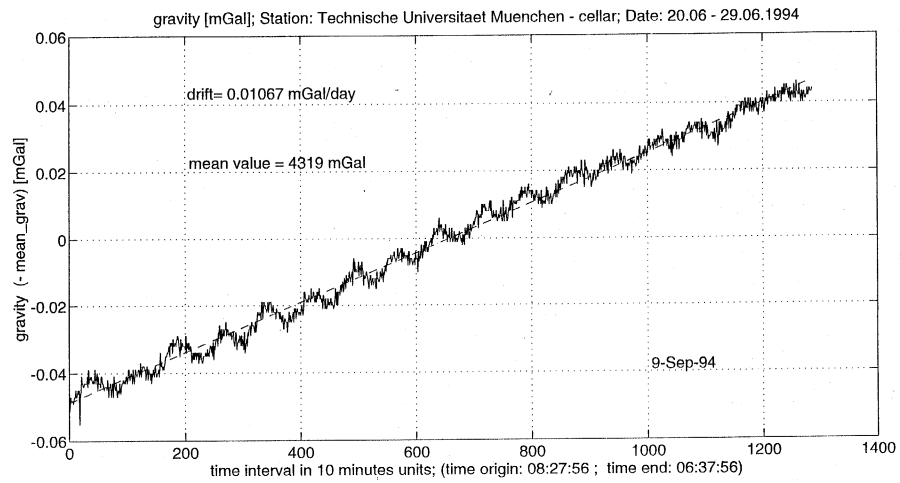

**Figure A—3** Continuous measurement over ten days showing the linear nature of drift together with other phenomena, such as ocean loading tide.

---

## Theory of Operation



# ELASTIC HYSTERESIS EFFECTS

All springs, however elastic, exhibit what is known as *elastic hysteresis* or *stress relaxation* effects. This occurs, for example, when the spring length is changed for a time (by a change in tension on the spring) and then returned to its original tension. When this happens, the spring does not instantaneously return to its original length, but has a small *memory* effect, which slowly relaxes with time and eventually disappears. The relaxation time may be of the same order as the length of time over which its tension was changed. Figure B-1 on page B-3 shows this effect graphically.

When the mainspring in a gravimeter is maintained at a constant length, as it will be at all times when it is balanced during a measurement, no hysteresis effect will occur. Between measurements, however, the balance condition will usually not prevail, and the spring will be subject to a change in length. Clamping the mass between measurements will fix the spring length but, unfortunately it will not do so at the usual balance condition, so that hysteresis effects are almost certain to occur as a result of clamping. In addition, gravimeters with reset mechanisms (e.g. LaCoste D meter) exhibit elastic hysteresis effects resulting from the change in mainspring tension caused by the reset, even though the mass remains fixed in position.

Figure B-2 on page B-3 shows the hysteresis effect of clamping on a LaCoste G meter, after only 20 minutes of clamping.

It is for such reasons that LaCoste gravimeter operators have learned to wait after releasing the clamp (e.g. 5 minutes), and longer after reset (D meter), in order to obtain higher reading repeatability.

---

## Elastic Hysteresis Effects

In the case of the CG-3, where the ruggedness of the inherent quartz element allows us to dispense with clamping between readings, and its universal range requires no resetting, we avoid the introduction of the hysteresis effects due to such causes. On the other hand, we allow the possibility of their introduction if the Autograv is left stationary, off level, i.e. out of its measuring range, for significant lengths of time. For this reason, it is recommended that whenever the Autograv is not being transported between stations, it should be levelled on its tripod so that the mass and spring are in their normal configuration. When in transit, hysteresis effects do not build up to any extent because the bipolar, high frequency changes in tension on the spring effectively cancel out any tendency for such effects to build up.

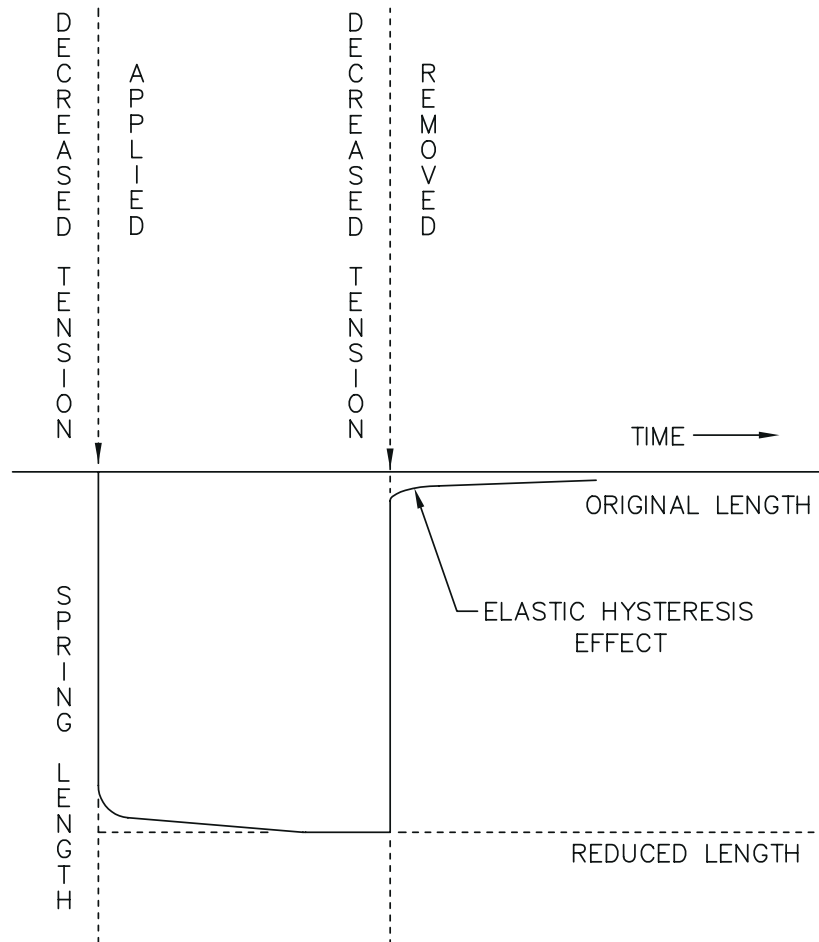

**Figure B—1** Elastic Hysteresis Effect

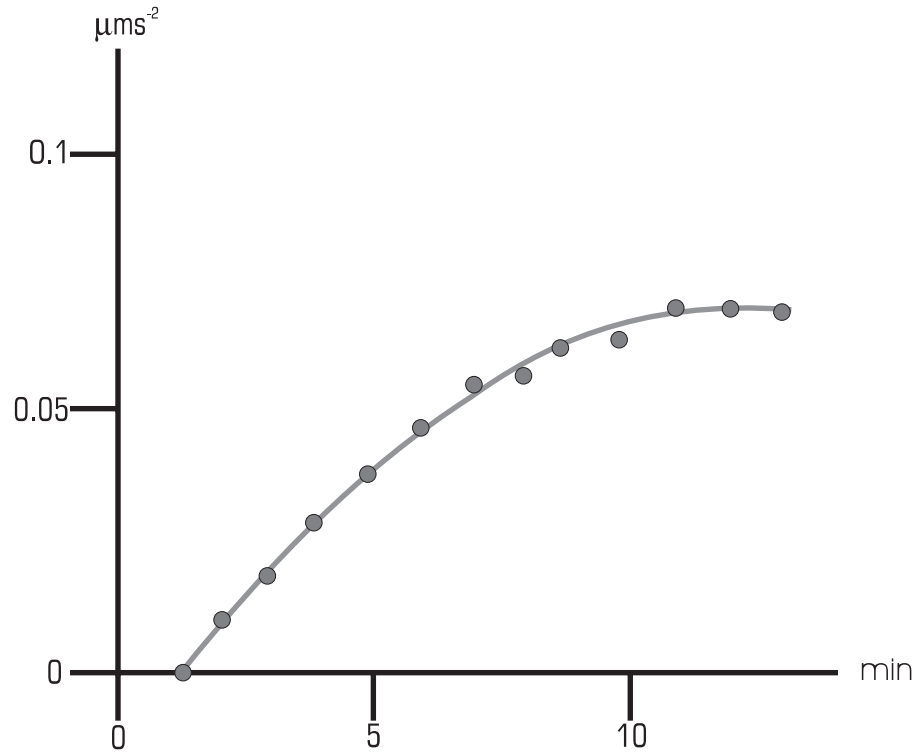

Hysteresis

**Figure B—2** Retardation effect after unclamping LaCoste Romberg gravimeter G79, previous clamping time 20 minutes. EFE Hanover (from *Gravimetry* by Wolfgang Torge, Walter de Gruyter, 1989.)

---

## Elastic Hysteresis Effects

# INTERFACING WITH THE AUTOGRAV

## RS 232C STANDARD

The Electronic Industry Association (EIA) established a standard for the interface between data terminal equipment (DTE) and data communication equipment (DCE) in 1963. The latest revision of this standard has been in effect since 1969, and is known as RS 232C. This standard specifies mechanical and electrical characteristics of the interface, the number of interchange circuits and their functions, and the relationship between these circuits and standard interface types. Standards similar to the RS 232C have also been established by the Comité Consultatif International Téléphonique et Télégraphique (CCITT). These standards, CCITT V.24 and CCITT V.28, are very similar to RS 232C but not identical.

The standard defines 22 pins and 3 unassigned pins. This does not imply a 25 pin connector, although this has become the industry standard. Conventionally, the male connector is used with the DTE and the female connector with DCE.

The Autograv used the IGS console as the data acquisition and control system. The IGS is RS 232C compatible. This does not mean it can immediately communicate with every other device so labelled. The statement RS 232C compatible means that none of the specifications defined by the standard EIA RS 232C are exceeded by the equipment. There may exist minor differences within this specification that preclude immediate communication. These incompatibilities may generally be overcome by reviewing pin assignments and re-wiring (by means of adapters) as necessary.

# IGS OUTPUT

## SERIAL I/O CONNECTIONS

The IGS is configured as *Data Communications Equipment* (DCE). Communication with other devices is via the RS-232C DB25S (female) connector on the front of the Autograv. Supplied with the instrument are a bi-directional serial RS 232C\* cable with a **NORMAL/REVERSE** switch, and an IGS-2 adapter†.

The adapter is first plugged into the instrument, then the cable (either end). The function of the **NORMAL/REVERSE** switch is to allow the instrument to be reconfigured as *Data Terminal Equipment* (DTE). This is performed by switching to the **REVERSE** position. This is necessary when attempting to communicate with another device configured as DCE. When the switch is set to **NORMAL** the instrument remains DCE. Generally, the **NORMAL** position is used to communicate with printers and computers. Try the **REVERSE** if the **NORMAL** does not work.

This switching is necessary because of the assignment of functions to certain pins in the RS 232C standard. The pins in question are **2** and **3**. The DCE mode expects to receive data on pin **2** and transmit data on pin **3** and the assignments are compatible for DTE communication. That is, DTE transmits through pin **2** and receives data on pin **3**.

When interfacing two pieces of DCE, it is necessary to switch to **REVERSE** so the signals are received on the appropriate pins (see Figure C-1).

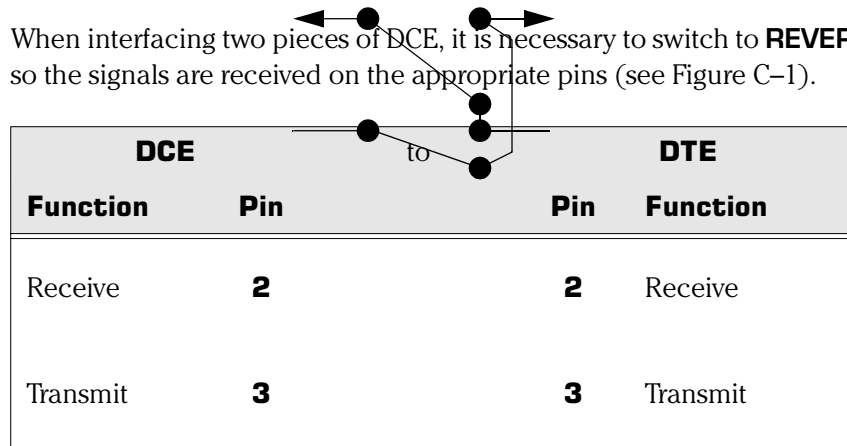

\* Scintrex Part Number 780 549  
† Scintrex Part Number 780 541

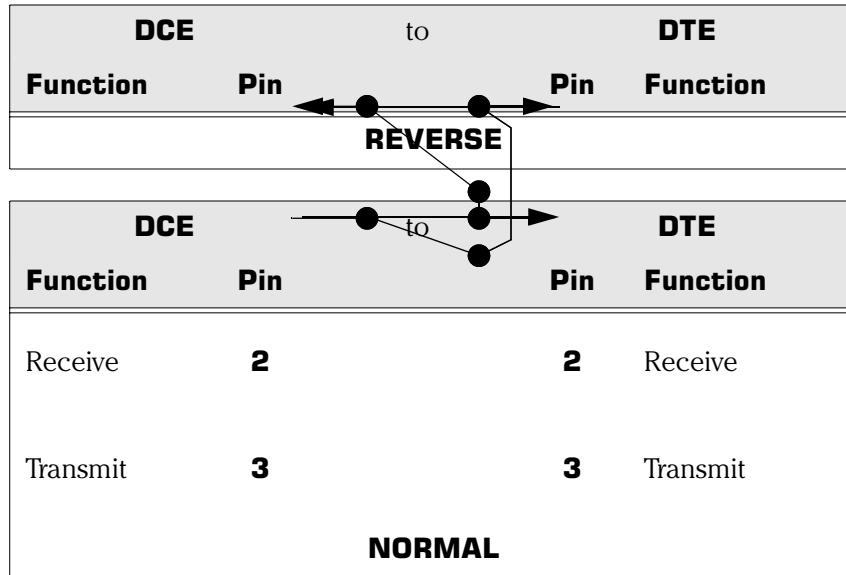

**Figure C—1** Function of the NORMAL/REVERSE Switch on the Serial RS-232C Cable

The important pin assignments are as follows:

Pin	Function
<b>2</b>	Receive
<b>3</b>	Transmit
<b>7</b>	Ground
<b>14</b>	EIAR1 (DTR)
<b>18</b>	Positive Battery
<b>24</b>	D/A out

The adapter between the Autograv and the serial RS 232C cable must be used. Damage may occur to either or both instruments if the adapter is not in place. The adapter wire as indicated in Figure C-2 and the serial RS 232C cable wiring appears as Figure C-3.

## Interfacing with the Autograv

**Note:** This adapter has the letter **A** engraved on its side. It differs from the older version, Scintrex part number 738 093, in that it allows the data dump at 2400 baud rate, for which pin **14** to pin **20** is required.

← DATA FLOW —

— DATA FLOW →

Male (Into Autograv)		Female (Into Serial RS-232C Cable)	
Description	Pin	Pin	Description
Receive	<b>2</b>	<b>2</b>	Transmit
Transmit	<b>3</b>	<b>3</b>	Receive
Positive Battery	<b>18</b>	<b>5</b>	Clear to Send
		<b>6</b>	Data Set Ready
		<b>8</b>	Carrier On
Ground	<b>7</b>	<b>7</b>	Signal Ground
D/A out	<b>24</b>	<b>25</b>	Analog Chart Recorder
EIAR1	<b>14</b>	<b>20</b>	Data Terminal Ready (DTR)

Figure C-2 ICS-RS 232C Wiring Diagram (P/N 780 541)

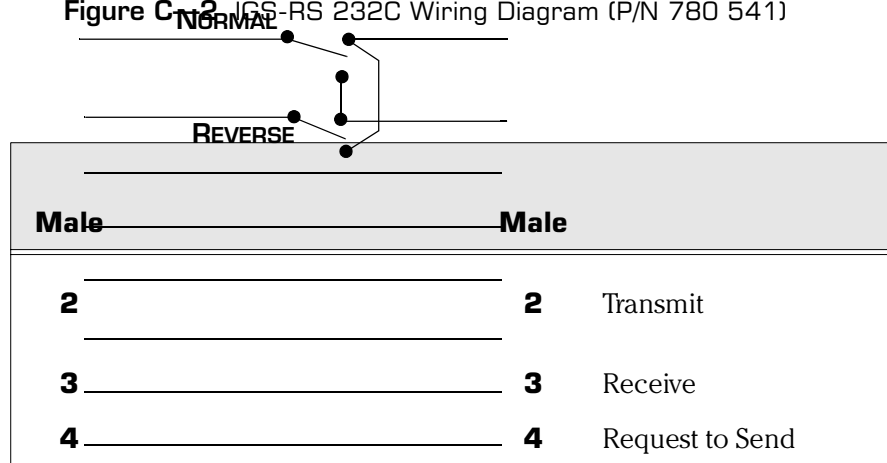



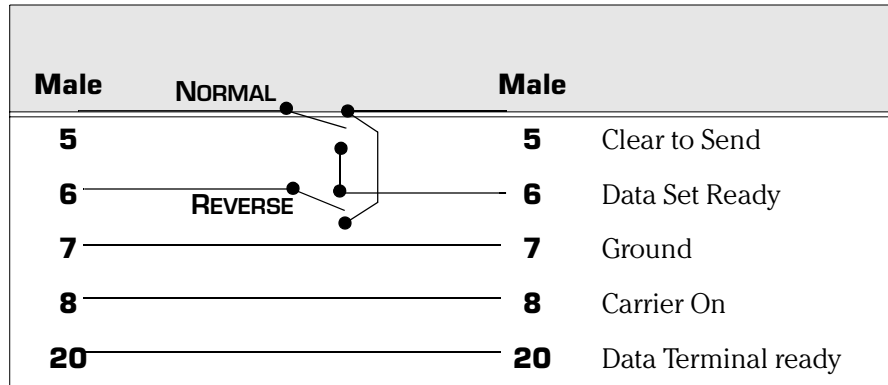

Figure C—3 Serial RS 232C Cable Wiring Diagram (P/N 780 549)

## SERIAL DATA FORMAT

**On transmit and receive**—1 start bit, 7 or 8 data bits (user selectable), no parity and 2 stop bits.

**Handshaking**—in all cases is via the X-ON (DC-1 or Control-Q)/X-OFF (DC-3 or Control-S) protocol.

**Baud rate**—Data are transmitted serially at a selectable baud rate between 110 and 2400 baud.

## TEXT TRANSMISSION SEQUENCE

Text is transmitted as ASCII characters. A dump (or plot) may consist of several sections, each of which contains a header and a data portion. Each section is preceded by and followed by a *null* line consisting of a carriage return <CR> and a line feed <LF>. The last section is followed by six *null* lines, indicating end of transmission. All other lines consist of, at most, 80 characters followed by a <CR> <LF>.

The operator, when in `OUTPUT MODE`, selects the carriage return delay (`n`). This is an integer and causes the insertion of `n` null characters after the last recorded character (i.e. <LF>) on each line. This is to ensure the host device (printer, computer etc.) has sufficient time to process each line of data before the next line is transmitted.

## COMMUNICATION SOFTWARE

Once the Autograv has been physically linked to a computer by means of adapters and serial cables, it is necessary to make them communicate. The interface software may be a commercially available communications package, or may be custom software dedicated to the user's hardware configuration.

Commercial communications packages tend to be quite comprehensive and for the simple function of transferring data to a computer from the Autograv are unnecessarily complicated.

Scintrex provides for the Autograv users communication software called **IDUMP**. This program is the property of Geosoft and is provided free of charge. Please observe all Geosoft requirements in the use and distribution of this software as stated in the copyright message. It supports serial port COM1/COM2 and a baud rate of up to 2400 BPS (for Autograv). It is self-documented and easy to use. Should you have any questions or concerns, please contact Scintrex Ltd.

# INITIAL CONSTANTS SHEET

AUTOGRAV SERIAL # \_\_\_\_\_

At time of shipping:

Parameter	Code	Value
Gravity constant #1	(GCAL1)	
Gravity constant #2	(GCAL2)	
Temperature constant	(TEMP)	
Tilt X sensitivity	(TILTXS)	
Tilt Y sensitivity	(TILTYS)	
Drift constant	(DRIFT)	

Constants

---

Autograv Technician

---

**Initial Constants Sheet**

### A

#### Accessories

- Optional 8-3
- Part numbers 8-5
- Standard 8-2

#### ADJUST mode 2-25

#### Adjusting

- Drift Correction 2-39
- Temp. compensation offset 2-34
- Tilt correction 6-4
- Tilt sensor
  - coarse zero 6-10
  - Cross-coupling 6-17
  - sensitivity 6-12
  - zero 6-4

#### X-axis Sensitivity (TILTXS) 6-13

#### Y-axis Sensitivity (TILTYs) 6-15

#### Auto Rejection 4-4

#### Autograv

- Handling 4-6
- Incomplete warmup stabilization 4-10
- Initialization constants
  - losing 5-2
- Instrument parameters 3-1
- Interfacing with C-1
- Keypad 2-6
- Leveling 2-28
- Maintenance 6-1
- Optional Accessories 8-3
- Overview 1-1
- Powering up 2-4
- Reset 7-2
- Setup 2-18
- Specifications 8-1
- stabilization period 2-3

#### Standard Accessories 8-2

- start-up sequence 2-3
- Storing 6-20
- Transporting 4-6
- Troubleshooting 7-1
- unpacking 2-2
- warm-up period 2-3

#### Autograv Setup

- AUTO REJECTION 3-22
- AUTO-RECORD 3-25
- CAL. AFTER 3-21
- CONT. TILT CORR. 3-21
- CYCLE TIME 3-17
- DRIFT CORRECTION 3-26
- INITIAL CONSTANTS 3-28
- MODE 3-16, 3-17
- READ TIME 3-17
- STOP ERR. <LIM> 3-20
- Submenus 3-16
- TIDE CORRECTION 3-22
- AUTOGRAV START DUMP 3-31

#### Automatic

- Record 3-25
- Rejection 3-22
- Shutoff 3-2
- Station increment 3-9

#### Aux (Auxiliary) key 2-8

#### Aux. mode

- locking 3-40
- unlocking 3-40

#### Auxiliary mode 3-1, 3-2

- Flowchart 2-14

## B

---

### B

- Battery 5-2
  - Changing 5-8
  - Charging time 5-6
  - Checking voltage 5-3
  - Cold weather operation 4-10
  - Compartment Fuse 5-8
  - External belt 5-2
  - Life expectancy 5-4
  - Low warning 5-3
  - Panasonic
    - 12V/7.2Ah 5-2, 5-5
    - LCR6V/7.2P 5-5
  - Replacing 5-5
  - Sonnenschein Dryfit A200 12V/6Ah 5-5
  - Temperature effects 5-2
    - voltage display update 5-4
- BAUD RATE 3-36
- BIAS1 3-33
- BIAS2 3-35
- Bottom function keys 2-9

### C

- CAL. AFTER 3-21, 4-2
- Calculating
  - Drift values
    - example 2-39
- Cancelling
  - measurement 3-18
- Change key 2-8
- Changing
  - Battery 5-8
  - Start time 3-27
- Charger 5-5
  - fuse 2-4, 5-7
  - Selecting alternate voltage 5-6
- Charging time 5-6
- Chart Recorder 6-3
- CHART SEL 3-19

- Checking
  - Battery voltage 5-3
  - Temperature compensation 2-31
- CHG? prompt 2-12
- Clear key 2-9
- Cold Weather Operation 4-10
- Communication
  - Software C-6
  - IDUMP 4-11, C-6
- Compensation
  - Temperature 6-1
  - Checking 2-31
- Console
  - Operation A-5
- CONT. TILT CORR. 3-21, 4-3
  - disabled 4-3
  - Selected 4-3
- Control Console A-5
- Correction
  - Drift 2-36, 6-2, A-12
  - Tide A-16
  - Tilt A-13
    - Continuous 4-3
- CR DELAY 3-38
- CYCLE TIME 3-17
  - CHART SEL 3-19
  - minimum value 3-18
- CYCLING
  - Mode 3-17

### D

- Data
  - Auto rejection 4-4
  - Displayed 8-2
  - dump 4-11
    - cannot 7-2
  - Entry
    - submenus 3-2
  - Key 2-7

- Notebook feature 4–5
- Output 2–37
- Recall
  - Cycling mode 2–46
  - Field mode 2–42
- recalling 2–42
- Recording 4–4
- Serial format C–5
- Types recorded 8–2
- DATA BITS 3–37
- Date
  - Reset 2–15
- DCE C–2
- Decimal key 2–9
- DEG. LAT 3–23
- DEG. LONG 3–24
- Digital display 8–2
- Direction key 2–9
- Display 2–10
  - battery voltage update 5–4
  - digital 8–2
  - error 2–25
  - gravity reading 2–25
  - Heater
    - Minor spare parts kit 8–3
  - Leveling parameters 2–25
  - Parameter set-up 2–10
  - SD 2–25
- Drift
  - calculating example 2–39
  - Correction 2–36, 6–2, A–12
    - adjusting 2–39
    - obtaining accurate 6–2
    - setting 3–26
  - measuring 2–36
  - residual long-term 8–1
- DRIFT CORRECTION 3–26
- DTE C–2
- DUMP ALL DATA 3–31
- Dumping Data 4–11
- Dust cover 4–6
  - removing 2–2

**E**

- Earth Tide Correction (ETC) A–16
- Earthquake shock waves 4–8
- EDIT mode 3–39
- Eliminating
  - noise spikes 4–4
- Enter
  - Key 2–9
  - Mode 2–6
  - Keys 2–9
- ENTER? prompt 2–12
- EPROM chips 3–1
- ERASE MEMORY 3–4
- Erasing memory 2–17
- Error display 2–25
- Error limit stop 3–20
- ETC A–16
- Examples
  - Calculating drift values 2–39
  - Changing read time 2–12
  - Data output printout 2–37
  - Initialise submenus 3–3
  - moving between menus 2–11
  - selecting a menu 2–11
- Exiting
  - Memory Mode 2–46
- Extender legs
  - Tripod 2–29
- External battery belt 5–2

**F**

- Field
  - Measurements
    - Mode 3–17
    - setting-up 2–41
  - Mode
    - Data recall 2–42
    - Operation 4–1
- FLD GRAV 3–17

## G

---

Flowchart  
  Auxiliary Mode 2–14  
Format  
  Serial data C–5  
Fuse  
  Battery compartment 5–8  
  Charger 5–7  
  charger 2–4

## G

GCAL1 6–18, A–7  
GCAL2 6–18, A–7  
Geosoft 4–11, C–6  
GMT. DIFF 3–24  
Gravimeter  
  recalibrating 6–18  
Gravimetric factor A–16  
Gravity  
  Stored readings A–6  
  Value display 2–25  
Gravity offset 3–25, A–17  
Gravity signal  
  Processing A–10  
Greenwich Mean Time 3–24  
GREF A–11, A–17  
GRID 3–6  
Ground conditions 4–8

## H

Handling 4–6  
  rough 4–7  
HEATER 3–12  
Hints  
  Cold weather operation 4–10  
  Earthquake shock waves 4–8  
  industrial traffic noise 4–8  
  Microseismic noise 4–8

Operation 4–6  
  poor ground conditions 4–8  
  Transportation 4–7  
  Wind noise 4–9

## I

IDUMP 4–11, C–6  
IGS Output C–2  
Industrial traffic noise 4–8  
Info key 2–8  
INITIAL CONSTANTS 3–28  
  Memory loss 5–2  
INITIALISE  
  Menu 3–3  
  Submenus 3–3  
Initialise  
  AUTO STN INC 3–9  
  ERASE MEMORY 3–4  
  GRID 3–6  
  HEATER 3–12  
  JOB NO. 3–5  
  LANG. ENGLISH 3–12  
  LINE 3–7  
  LINE DIR 3–6  
  OPERATOR 3–5  
  REC AUTOSTART 3–11  
  SERIAL # 3–11  
  STATION 3–8  
  TIME 3–13  
Initializing 2–15  
  Parameters/Software 2–15  
Instrument parameters 3–1  
Interfacing  
  Autograv C–1

## J

JOB NO. 3–5



**K**

- Key functions 2–6, 2–7
  - Enter mode 2–9
  - Operations mode 2–7
- Keypad 2–6
  - Input 8–2
  - Operation 4–1
- Keys
  - +/- 2–9
  - Aux 2–8
  - Bottom functions 2–9
  - Change 2–8
  - Clear 2–9
  - Data 2–7
  - Decimal 2–9
  - Direction 2–9
  - Enter 2–9
  - Info 2–8
  - Line 2–7
  - Memory 2–7
  - Method 2–7
  - NE/SW 2–9
  - Numeric 2–9
  - On/Off 2–7
  - Record 2–7
  - Scrolling 2–8
  - Start/Stop 2–9
  - Station 2–8
  - Top Functions 2–7

**L**

- LANG. ENGLISH 3–12
- Latitude 3–23
- Leveling 2–28
  - Parameters display 2–25
  - Requirements 4–3
- Life expectancy
  - Batteries 5–4
- LINE 3–7

**Line**

- direction 3–6, 3–10
- key 2–7
- separation 3–14
- LINE DIR 3–6
- LINE SEP 3–14
- Line Separation mode 3–14
- LOCK AUX. 3–40
- Locking Auxiliary mode 3–40
- Longitude 3–24
- Longman formula A–16
- Low battery warning 5–3

**M****Main Menu**

- (Aux. Mode) 3–1
- flowchart 2–14

**Maintenance**

- Autograv 6–1
- Tripod 6–20

**Measurement**

- cancelling 3–18
- Field setup 2–41

**Measuring**

- Drift 2–36
- gravity 2–41
- Tilt Sensor cross-coupling 6–16
- X-axis Sensitivity (TILTXS) 6–12
- XE 6–4
- Y-axis Sensitivity (TILTYYS) 6–14
- YE 6–8

**Memory**

- Directly accessing records 2–45
- erasing 2–17
- keys 2–7
- Loss 5–2, 7–2
- Mode
  - Exiting 2–46
- Scrolling 2–42

## N

---

- Standard 8-1
- Menu
  - INITIALISE 3-3
  - Main 3-1
    - flowchart 2-14
- Menus
  - moving between 2-10
  - Selecting 2-11
  - Structure 2-10
- Method key 2-7
- Microseismic noise 4-8
- Minimum cycle time 3-18
- MODE
  - Selection 3-17
- Mode
  - Adjust 2-25
  - AUTOGRAV SETUP 3-16
  - Aux.
    - Locking 3-40
    - unlocking 3-40
  - Auxiliary 3-2
  - Auxiliary (Main Menu) 3-1
  - CYCLING 3-17
    - recalling data 2-46
  - EDIT 3-39
  - ENTER 2-6
  - Field
    - data recall 2-42
  - FLD GRV 3-17
  - LINE SEP 3-14
  - Memory
    - Exiting 2-46
  - NONE 3-17
  - OPERATION 2-6
  - OUTPUT 3-30
  - Pause 2-25
  - STN SEP 3-15
- Modes
  - operating 2-6, A-5
- Modifying
  - parameters

- CHG? 2-12
  - paramters 2-12
- Motion Noise 4-8

## N

- NE/SW key 2-9
- Noise A-11
  - Earthquake shock waves 4-8
  - Industrial traffic 4-8
  - Microseismic 4-8
  - moition 4-8
  - Rejection 8-2
  - spikes
    - eliminating 4-4
  - Wind 4-9
- NONE 3-17
- Notebook Feature 4-5
- Numeric keys 2-9

## O

- On/Off key 2-7
- Operating
  - modes 2-6, A-5
- Operation
  - Cold weather 4-10
  - Console A-5
  - Hints 4-6
  - Keypad 4-1
  - Mode 2-6
    - Keys 2-7
- OPERATOR 3-5
- Options
  - Part numbers 8-5
- Output 3-32
  - AUTOGRAV START DUMP 3-31
  - BAUD RATE 3-36
  - CR DELAY 3-38

- Data 2–37
  - DATA BITS 3–37
  - DUMP ALL DATA 3–31
  - IGS C–2
  - Mode 3–30
  - Submenus 3–31
- P**
- Panasonic
    - 12V/7.2Ah battery 5–2
    - LCR6V/7.2P 5–5
  - Parameters
    - Initializing 2–15
    - Instrument 3–1
    - modifying 2–12
      - ENTER? 2–12
      - SELECT/ENTER 2–12
  - Parameters set-up
    - display 2–10
  - Parts List 8–5
  - Pause mode 2–25
  - PLOT 3–32
    - parameters 3–32, 3–34
      - BIAS! 3–33
      - BIAS2 3–35
      - SCALE2 3–35
      - START PLOT 3–36
      - TRACE1 3–32
      - TRACE2 3–35
    - Trace 3–32
  - Plus/Minus keys 2–9
  - Power
    - Consumption 8–1
    - loss 5–1
    - Off
      - Consequences 5–1
      - Off Time and stabilization 5–2
  - Powering up 2–4
  - Processing
    - Gravity Signal A–10
- Prompt line 2–10
- Prompts
  - CHG? 2–12
  - ENTER? 2–12
  - SELECT/ENTER 2–12
- Proof mass A–1
- Q**
- Quartz elastic system A–1
- R**
- Range
    - Automatic Tilt correction 8–1
    - Operating temperature 8–1
    - Readings A–7
  - Ratio
    - Internal Cal. to Gravity samples 4–2
  - READ TIME 3–17
  - Reading
    - Out-of-range 7–1
    - Range A–7
    - Repeatability 8–1
    - Resolution 8–1
    - Terminating 4–2
    - Time 4–2
  - Real Time Clock 8–2
  - REC AUTOSTART 3–11
  - Recalibrating gravimeter 6–18
  - Recalling Data
    - Cycling mode 2–46
    - Field mode 2–42
  - Record key 2–7
  - Recording
    - Data 4–4
    - Notebook feature 4–5
  - Records

## S

---

- Scanning 2–43
- Repair 8–7
- Repeatability
  - readings 8–1
- Replacing Batteries 5–5
- Reset
  - Autograv 7–2
  - date 2–15
  - time 2–15
- Resolution
  - Reading 8–1
- RS 232C C–1

## S

- SCALE1 3–34
- SCALE2 3–35
- Scanning
  - Records 2–43
- Scroll keys 2–8
- Scrolling in memory 2–42
- SD display 2–25
- SELECT/ENTER prompt 2–12
- Selecting
  - Charger voltage 5–6
  - Mode of operation 3–17
- Sensor
  - Latched 7–1
  - Unlatching 7–1
- SERIAL # 3–11
- Serial data format C–5
- Service Life
  - Spring A–7
- Setting
  - Drift correction 3–26
- Setting-up
  - Autograv 2–18
  - Field Measurements 2–41
  - Tripod 2–26
- Sign conventions 2–44

- Software 2–15, 8–4
  - Communication C–6
- Sonnenschein Dryfit A200 12V/6Ah 5–5
- Spare Parts Kit 8–6
- Springs
  - Service Life A–7
  - Stress relaxation B–1
- Stabilization period 2–3
- Standard deviation A–11
  - value display 2–25
- START PLOT 3–36
- Start/Stop key 2–9
- Station
  - Auto-increment 3–9
    - disabled 3–10
    - selected 3–9
  - Initialise 3–8
  - Key 2–8
  - Separation 3–15
- Station Separation mode 3–15
- STOP ERR. 3–20
- Storing
  - Autograv 6–20
- Stress relaxation
  - Springs B–1
- Submenus
  - Autograv Setup 3–16
  - Data entry 3–2
  - Initialise 3–3
  - Output 3–31
  - Returning from 3–2

## T

- TEC A–15
- Temperature
  - Compensation 6–1, A–15
    - adjusting offset 2–34
    - checking 2–31
    - offset 2–32

- TEC A-15
  - Effects
    - Batteries 5-2
  - Terminating
    - Readings 4-2
  - Text transmission sequence C-6
  - Theory of Operation A-1
  - Thermostat
    - stability 5-1
  - TIC A-13
  - Tide
    - Correction A-16
  - TIDE CORRECTION 3-22
    - DEG. LAT 3-23
    - DEG. LONG 3-24
    - GMT. DIFF 3-24
  - Tilt
    - Correction A-13
      - Adjustment 6-4
      - continuous 4-3
    - TIC A-13
  - Tilt Sensor
    - Adjusting
      - cross-coupling 6-17
      - sensitivity 6-12
      - zero 6-4
    - Coarse Zero Adjustment 6-10
    - Cross-Coupling 6-16
      - adjusting 6-17
      - measuring 6-16
    - Sensitivity Adjustment (tiltxs, tiltys) 6-12
    - Zero Adjustments 6-4
  - TILTXS 6-12
    - adjusting 6-13
    - measuring 6-12
  - TILTYS
    - adjusting 6-15
    - measuring 6-14
  - Time
    - Battery charging 5-6
    - Changing start 3-27
    - Cycle 3-17
    - Initialising 3-13
      - reading 4-2
    - Reset 2-15
    - Top keys 2-7
    - Trace 3-32
    - TRACE1 3-32
    - TRACE2 3-35
    - Training 8-4
    - Transportation 4-7
      - Autograv 4-6
        - case 2-2
      - Rough handling 4-7
    - Tripod
      - Extender Legs 2-29
      - Maintenance 6-20
        - on a hard surface 4-3
        - on a soft surface 2-29
      - setup 2-26
    - Troubleshooting 7-1
- U**
- Unlatching sensor 7-1
  - Unlocking Auxiliary mode 3-40
  - Unpacking
    - Autograv 2-2
- V**
- Vee-groove plate 6-17
  - Voltage 5-3
    - checking 5-3
- W**
- Warm-up period 2-3
  - Warning

## **X**

---

Low battery 5-3  
Warranty 8-7  
Weight 8-1  
Wind 4-9

## **X**

XE

Coarse adjustment 6-10  
Fine Adjustment 6-6  
Measuring 6-4

## **Y**

YE

Coarse adjustment 6-11  
Fine adjustment 6-9  
Measuring 6-8